

D2541 SERIES

2.54mm pitch IDC wire to board connector

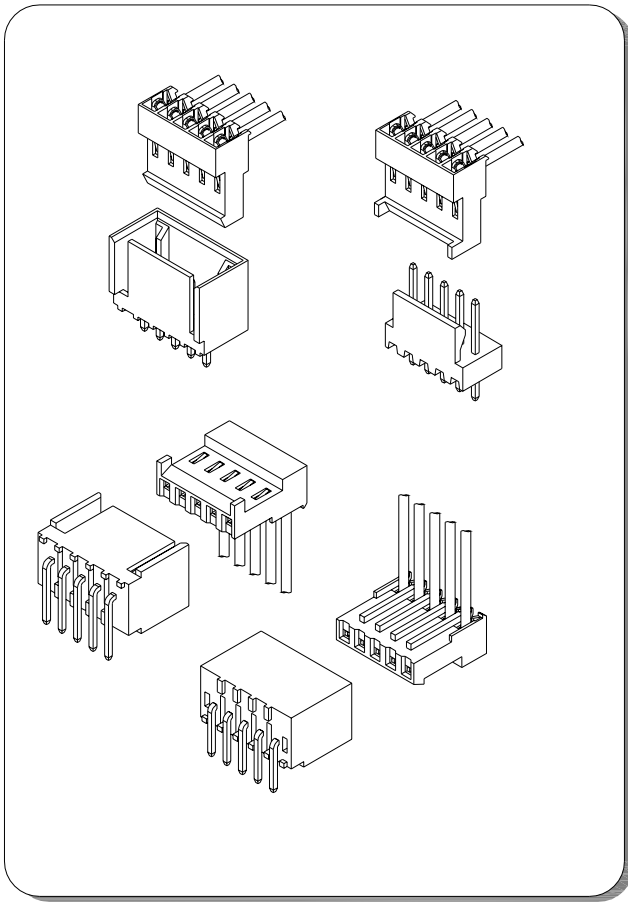

Specifications

- Current rating:3A AC,DC
- Voltage rating:250V AC,DC
- Temperature range:-40°C~+105°C
- Contact resistance:20mΩMax.
- Insulation resistance:1000MΩMin.
- Withstanding voltage:1500V AC/minute
- *Compliant with RoHS and REACH*
- *Meet the HF/Halogen Free,need to customize*
- *Contact for details*

Standards



Assembly layout

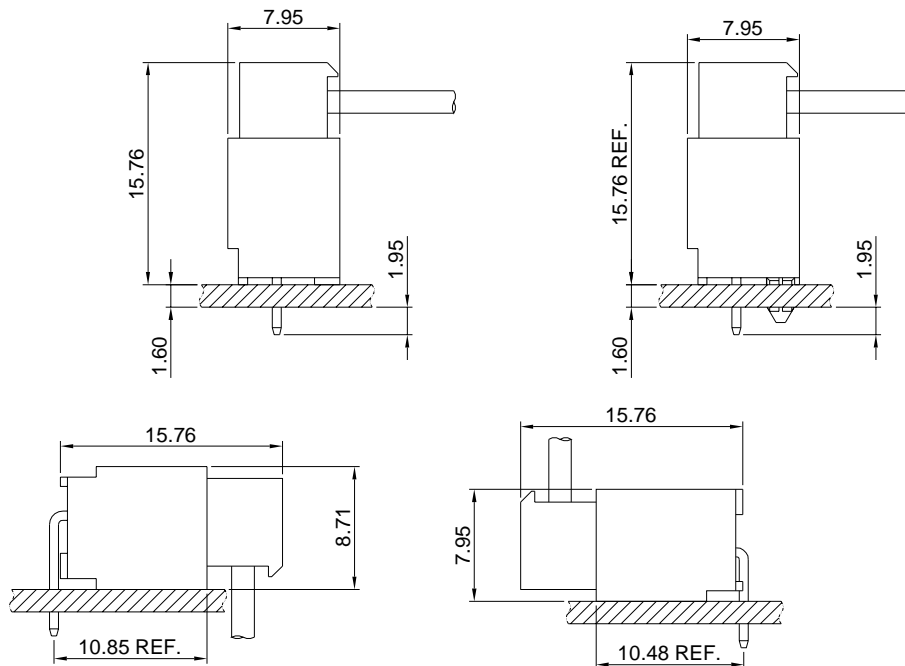

D2541 SERIES

2.54mm pitch IDC wire to board connector

D2541H

2.54mm IDC Closed End Type

Reference Informations:

- *Material:
Terminal: Phosphor bronze
Housing: Nylon66, UL 94V-2 or UL94V-0
- *Mates with D2541 A2543WVA
A2543WRA series Wafer

Ordering Information:

D2541H-XP - ** -**
1 2 3

- 1: Part No.
- 2: Material:
RD-Red=22 AWG(UL94V-2)
WH-White=24 AWG(UL94V-2)
BL-Blue=26 AWG(UL94V-2)
GN-Green=28 AWG(UL94V-2)
BK-Black=All wire sizes in UL94V-0
- 3: Plating Code:
(Blank)-Phosphor bronze/Tin over Nickel
GP-Phosphor bronze/Gold over Nickel
(Optional Gold plating available but MOQ requested)

Ordering Information & Dimensions:

PART NO.	Dimensions	
	A	B
D2541H-2P-**-**	2.54	5.08
D2541H-3P-**-**	5.08	7.62
D2541H-4P-**-**	7.62	10.16
D2541H-5P-**-**	10.16	12.70
D2541H-6P-**-**	12.70	15.24
D2541H-7P-**-**	15.24	17.78
D2541H-8P-**-**	17.78	20.32
D2541H-9P-**-**	20.32	22.86
D2541H-10P-**-**	22.86	25.40
D2541H-11P-**-**	25.40	27.94
D2541H-12P-**-**	27.94	30.48
D2541H-13P-**-**	30.48	33.02
D2541H-14P-**-**	33.02	35.56
D2541H-15P-**-**	35.56	38.10
D2541H-16P-**-**	38.10	40.64
D2541H-17P-**-**	40.64	43.18
D2541H-18P-**-**	43.18	45.72
D2541H-19P-**-**	45.72	48.26
D2541H-20P-**-**	48.26	50.80
D2541H-21P-**-**	50.80	53.34
D2541H-22P-**-**	53.34	55.88
D2541H-23P-**-**	55.88	58.42
D2541H-24P-**-**	58.42	60.96

Unit: mm

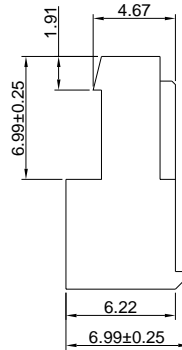
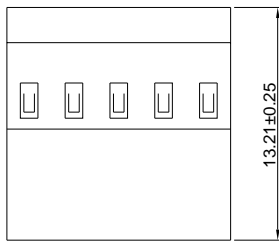
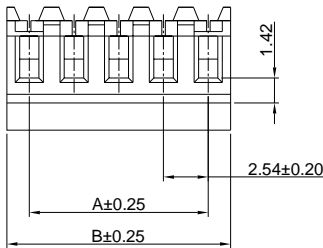

D2541HA

2.54mm IDC Closed End Type

Reference Informations:

- *Material:
Terminal: Phosphor bronze
Housing: Nylon66, UL 94V-2 or UL94V-0
- *Mates with D2541 A2543WVA
A2543WRA series Wafer

Ordering Information:

D2541HA-XP - ** -**
1 2 3

- 1: Part No.
- 2: Material:
RD-Red=22 AWG(UL94V-2)
WH-White=24 AWG(UL94V-2)
BL-Blue=26 AWG(UL94V-2)
GN-Green=28 AWG(UL94V-2)
BK-Black=All wire sizes in UL94V-0
- 3: Plating Code:
(Blank)-Phosphor bronze/Tin over Nickel
GP-Phosphor bronze/Gold over Nickel
(Optional Gold plating available but MOQ requested)

Ordering Information & Dimensions:

PART NO.	Dimensions	
	A	B
D2541HA-2P-**-**	2.54	5.08
D2541HA-3P-**-**	5.08	7.62
D2541HA-4P-**-**	7.62	10.16
D2541HA-5P-**-**	10.16	12.70
D2541HA-6P-**-**	12.70	15.24
D2541HA-7P-**-**	15.24	17.78
D2541HA-8P-**-**	17.78	20.32
D2541HA-9P-**-**	20.32	22.86
D2541HA-10P-**-**	22.86	25.40
D2541HA-11P-**-**	25.40	27.94
D2541HA-12P-**-**	27.94	30.48
D2541HA-13P-**-**	30.48	33.02
D2541HA-14P-**-**	33.02	35.56
D2541HA-15P-**-**	35.56	38.10
D2541HA-16P-**-**	38.10	40.64
D2541HA-17P-**-**	40.64	43.18
D2541HA-18P-**-**	43.18	45.72
D2541HA-19P-**-**	45.72	48.26
D2541HA-20P-**-**	48.26	50.80
D2541HA-21P-**-**	50.80	53.34
D2541HA-22P-**-**	53.34	55.88
D2541HA-23P-**-**	55.88	58.42
D2541HA-24P-**-**	58.42	60.96

Unit: mm

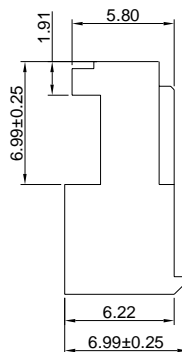
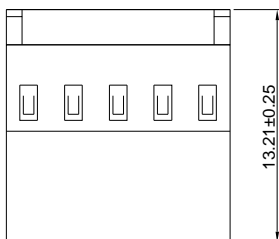
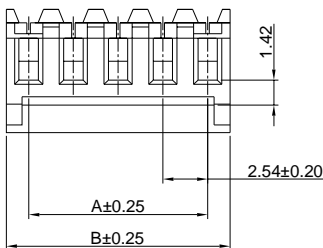

D2541 SERIES

2.54mm pitch IDC wire to board connector

D2541HB

2.54mm IDC Feed-Thru Connector

Reference Informations:

- *Material:
Terminal: Phosphor bronze
Housing: Nylon66, UL 94V-2 or UL94V-0
- *Mates with D2541 A2543WVA
A2543WRA series Wafer

Ordering Information:

D2541HB-XP - ** .**
1 2 3

- 1: Part No.
- 2: Material:
RD-Red=22 AWG(UL94V-2)
WH-White=24 AWG(UL94V-2)
BL-Blue=26 AWG(UL94V-2)
GN-Green=28 AWG(UL94V-2)
BK-Black=All wire sizes in UL94V-0
- 3: Plating Code:
(Blank)-Phosphor bronze/Tin over Nickel
GP-Phosphor bronze/Gold over Nickel
(Optional Gold plating available but MOQ requested)

Ordering Information & Dimensions:

PART NO.	Dimensions	
	A	B
D2541HB-2P-**-**	2.54	5.08
D2541HB-3P-**-**	5.08	7.62
D2541HB-4P-**-**	7.62	10.16
D2541HB-5P-**-**	10.16	12.70
D2541HB-6P-**-**	12.70	15.24
D2541HB-7P-**-**	15.24	17.78
D2541HB-8P-**-**	17.78	20.32
D2541HB-9P-**-**	20.32	22.86
D2541HB-10P-**-**	22.86	25.40
D2541HB-11P-**-**	25.40	27.94
D2541HB-12P-**-**	27.94	30.48
D2541HB-13P-**-**	30.48	33.02
D2541HB-14P-**-**	33.02	35.56
D2541HB-15P-**-**	35.56	38.10
D2541HB-16P-**-**	38.10	40.64
D2541HB-17P-**-**	40.64	43.18
D2541HB-18P-**-**	43.18	45.72
D2541HB-19P-**-**	45.72	48.26
D2541HB-20P-**-**	48.26	50.80
D2541HB-21P-**-**	50.80	53.34
D2541HB-22P-**-**	53.34	55.88
D2541HB-23P-**-**	55.88	58.42
D2541HB-24P-**-**	58.42	60.96

Unit: mm

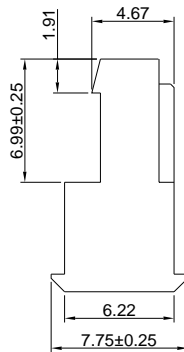
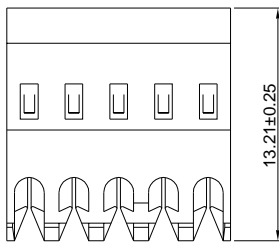
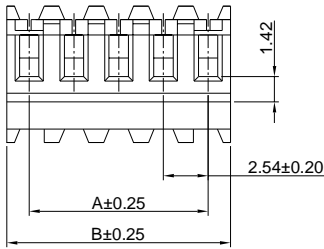

D2541HC

2.54mm IDC Feed-Thru Connector

Reference Informations:

- *Material:
Terminal: Phosphor bronze
Housing: Nylon66, UL 94V-2 or UL94V-0
- *Mates with D2541 A2543WVA
A2543WRA series Wafer

Ordering Information:

D2541HC-XP - ** .**
1 2 3

- 1: Part No.
- 2: Material:
RD-Red=22 AWG(UL94V-2)
WH-White=24 AWG(UL94V-2)
BL-Blue=26 AWG(UL94V-2)
GN-Green=28 AWG(UL94V-2)
BK-Black=All wire sizes in UL94V-0
- 3: Plating Code:
(Blank)-Phosphor bronze/Tin over Nickel
GP-Phosphor bronze/Gold over Nickel
(Optional Gold plating available but MOQ requested)

Ordering Information & Dimensions:

PART NO.	Dimensions	
	A	B
D2541HC-2P-**-**	2.54	5.08
D2541HC-3P-**-**	5.08	7.62
D2541HC-4P-**-**	7.62	10.16
D2541HC-5P-**-**	10.16	12.70
D2541HC-6P-**-**	12.70	15.24
D2541HC-7P-**-**	15.24	17.78
D2541HC-8P-**-**	17.78	20.32
D2541HC-9P-**-**	20.32	22.86
D2541HC-10P-**-**	22.86	25.40
D2541HC-11P-**-**	25.40	27.94
D2541HC-12P-**-**	27.94	30.48
D2541HC-13P-**-**	30.48	33.02
D2541HC-14P-**-**	33.02	35.56
D2541HC-15P-**-**	35.56	38.10
D2541HC-16P-**-**	38.10	40.64
D2541HC-17P-**-**	40.64	43.18
D2541HC-18P-**-**	43.18	45.72
D2541HC-19P-**-**	45.72	48.26
D2541HC-20P-**-**	48.26	50.80
D2541HC-21P-**-**	50.80	53.34
D2541HC-22P-**-**	53.34	55.88
D2541HC-23P-**-**	55.88	58.42
D2541HC-24P-**-**	58.42	60.96

Unit: mm

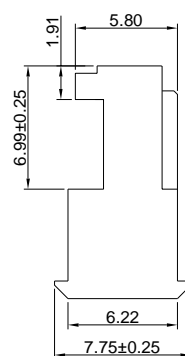
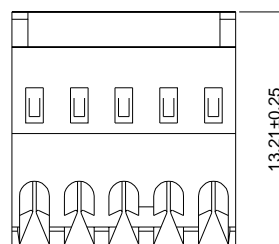
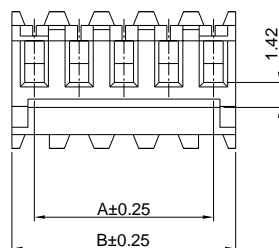

D2541 SERIES

2.54mm pitch IDC wire to board connector

D2541HD

2.54mm IDC Closed End IDC Connector

Reference Informations:

- *Material:
Terminal: Phosphor bronze
Housing: Nylon66, UL 94V-2 or UL94V-0
- *Mates with D2541 A2543WVA
A2543WRA series Wafer

Ordering Information:

D2541HD-XP - ** _**
1 2 3

- 1: Part No.
- 2: Wire Range and Material:
2-22 AWG (UL94V-2)
4-24 AWG (UL94V-2)
6-26 AWG (UL94V-2)
8-28 AWG (UL94V-2)
- 3: Plating Code:
(Blank)-Phosphor bronze/Tin over Nickel
GP-Phosphor bronze/Gold over Nickel
(Optional Gold plating available but MOQ requested)

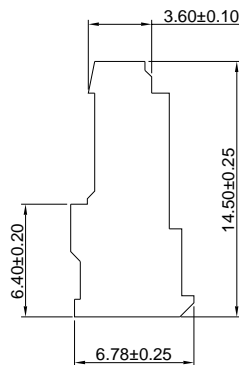
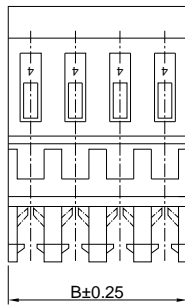
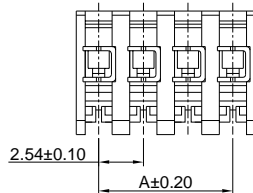

Ordering Information & Dimensions:

PART NO.	Dimensions	
	A	B
D2541HD-2P-**-**	2.54	5.08
D2541HD-3P-**-**	5.08	7.62
D2541HD-4P-**-**	7.62	10.16
D2541HD-5P-**-**	10.16	12.70
D2541HD-6P-**-**	12.70	15.24
D2541HD-7P-**-**	15.24	17.78
D2541HD-8P-**-**	17.78	20.32
D2541HD-9P-**-**	20.32	22.86
D2541HD-10P-**-**	22.86	25.40
D2541HD-11P-**-**	25.40	27.94
D2541HD-12P-**-**	27.94	30.48
D2541HD-13P-**-**	30.48	33.02
D2541HD-14P-**-**	33.02	35.56
D2541HD-15P-**-**	35.56	38.10
D2541HD-16P-**-**	38.10	40.64
D2541HD-17P-**-**	40.64	43.18

Unit: mm

D2541HE

2.54mm IDC Closed End IDC Connector

Reference Informations:

- *Material:
Terminal: Phosphor bronze
Housing: Nylon66, UL 94V-2 or UL94V-0
- *Mates with D2541 A2543WVA
A2543WRA series Wafer

Ordering Information:

D2541HE-XP - ** _**
1 2 3

- 1: Part No.
- 2: Wire Range and Material:
2-22 AWG (UL94V-2)
4-24 AWG (UL94V-2)
6-26 AWG (UL94V-2)
8-28 AWG (UL94V-2)
- 3: Plating Code:
(Blank)-Phosphor bronze/Tin over Nickel
GP-Phosphor bronze/Gold over Nickel
(Optional Gold plating available but MOQ requested)

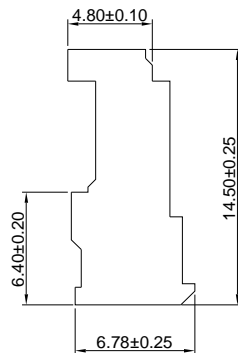
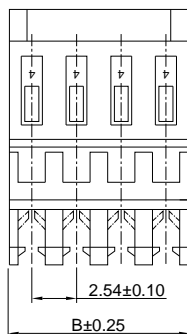
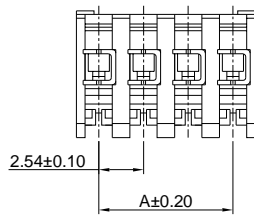

Ordering Information & Dimensions:

PART NO.	Dimensions	
	A	B
D2541HE-2P-**-**	2.54	5.08
D2541HE-3P-**-**	5.08	7.62
D2541HE-4P-**-**	7.62	10.16
D2541HE-5P-**-**	10.16	12.70
D2541HE-6P-**-**	12.70	15.24
D2541HE-7P-**-**	15.24	17.78
D2541HE-8P-**-**	17.78	20.32
D2541HE-9P-**-**	20.32	22.86
D2541HE-10P-**-**	22.86	25.40
D2541HE-11P-**-**	25.40	27.94
D2541HE-12P-**-**	27.94	30.48
D2541HE-13P-**-**	30.48	33.02
D2541HE-14P-**-**	33.02	35.56
D2541HE-15P-**-**	35.56	38.10
D2541HE-16P-**-**	38.10	40.64
D2541HE-17P-**-**	40.64	43.18

Unit: mm

D2541 SERIES

2.54mm pitch IDC wire to board connector

D2541HF

2.54mm IDC Closed End IDC Connector

Reference Informations:

- *Material:
Terminal: Phosphor bronze
Housing: Nylon66, UL 94V-2 or UL94V-0
- *Mates with D2541 A2543WVA
A2543WRA series Wafer

Ordering Information:

D2541HF-XP - ** - **
1 2 3

- 1: Part No.
- 2: Wire Range and Material:
2-22 AWG (UL94V-2)
4-24 AWG (UL94V-2)
6-26 AWG (UL94V-2)
8-28 AWG (UL94V-2)
- 3: Plating Code:
(Blank)-Phosphor bronze/Tin over Nickel
GP-Phosphor bronze/Gold over Nickel
(Optional Gold plating available but MOQ requested)

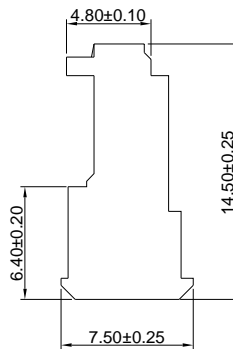
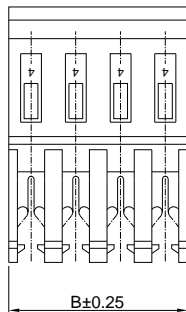
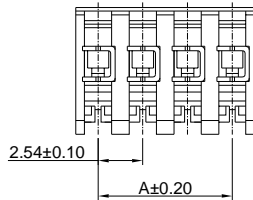

Ordering Information & Dimensions:

PART NO.	Dimensions	
	A	B
D2541HF-2P-**-**	2.54	5.08
D2541HF-3P-**-**	5.08	7.62
D2541HF-4P-**-**	7.62	10.16
D2541HF-5P-**-**	10.16	12.70
D2541HF-6P-**-**	12.70	15.24
D2541HF-7P-**-**	15.24	17.78
D2541HF-8P-**-**	17.78	20.32
D2541HF-9P-**-**	20.32	22.86
D2541HF-10P-**-**	22.86	25.40
D2541HF-11P-**-**	25.40	27.94
D2541HF-12P-**-**	27.94	30.48
D2541HF-13P-**-**	30.48	33.02
D2541HF-14P-**-**	33.02	35.56
D2541HF-15P-**-**	35.56	38.10
D2541HF-16P-**-**	38.10	40.64
D2541HF-17P-**-**	40.64	43.18

Unit: mm

D2541HG

2.54mm IDC Closed End IDC Connector

Reference Informations:

- *Material:
Terminal: Phosphor bronze
Housing: Nylon66, UL 94V-2 or UL94V-0
- *Mates with D2541 A2543WVA
A2543WRA series Wafer

Ordering Information:

D2541HG-XP - ** - **
1 2 3

- 1: Part No.
- 2: Wire Range and Material:
2-22 AWG (UL94V-2)
4-24 AWG (UL94V-2)
6-26 AWG (UL94V-2)
8-28 AWG (UL94V-2)
- 3: Plating Code:
(Blank)-Phosphor bronze/Tin over Nickel
GP-Phosphor bronze/Gold over Nickel
(Optional Gold plating available but MOQ requested)

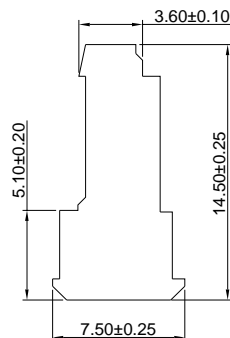
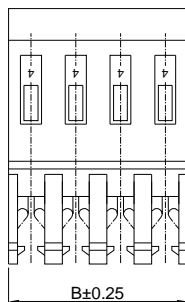
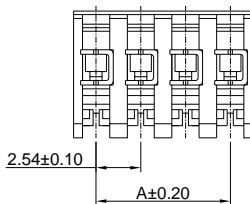

Ordering Information & Dimensions:

PART NO.	Dimensions	
	A	B
D2541HG-2P-**-**	2.54	5.08
D2541HG-3P-**-**	5.08	7.62
D2541HG-4P-**-**	7.62	10.16
D2541HG-5P-**-**	10.16	12.70
D2541HG-6P-**-**	12.70	15.24
D2541HG-7P-**-**	15.24	17.78
D2541HG-8P-**-**	17.78	20.32
D2541HG-9P-**-**	20.32	22.86
D2541HG-10P-**-**	22.86	25.40
D2541HG-11P-**-**	25.40	27.94
D2541HG-12P-**-**	27.94	30.48
D2541HG-13P-**-**	30.48	33.02
D2541HG-14P-**-**	33.02	35.56
D2541HG-15P-**-**	35.56	38.10
D2541HG-16P-**-**	38.10	40.64
D2541HG-17P-**-**	40.64	43.18

Unit: mm

D2541 SERIES

2.54mm pitch IDC wire to board connector

D2541WV

2.54mm IDC 180° Wafer

Reference Informations:

- *Material:Pin:Brass/Tin over Nickel
Insulator:PBT,UL94V-0
- *Mates with D2541 series Housing
- *Color:Black

Ordering Information:

- D2541WV-XP - *
1 2
- 1.Part No.
 - 2.Finish:
(Blank):Brass/Tin over Nickel
G:Brass/Gold over Nickel

Ordering Information & Dimensions:

PART NO.	Dimensions	
	A	B
D2541WV-2P	2.54	7.21
D2541WV-3P	5.08	9.75
D2541WV-4P	7.62	12.29
D2541WV-5P	10.16	14.83
D2541WV-6P	12.70	17.37
D2541WV-7P	15.24	19.91
D2541WV-8P	17.78	22.45
D2541WV-9P	20.32	24.99
D2541WV-10P	22.86	27.53
D2541WV-11P	25.40	30.07
D2541WV-12P	27.94	32.61
D2541WV-13P	30.48	35.15
D2541WV-14P	32.02	37.69
D2541WV-15P	35.56	40.23
D2541WV-16P	38.10	42.77
D2541WV-17P	40.64	45.31
D2541WV-18P	43.18	47.85
D2541WV-19P	45.72	50.39
D2541WV-20P	48.26	52.93
D2541WV-21P	50.80	55.47
D2541WV-22P	53.34	58.01
D2541WV-23P	55.88	60.55
D2541WV-24P	58.42	63.09

Unit: mm

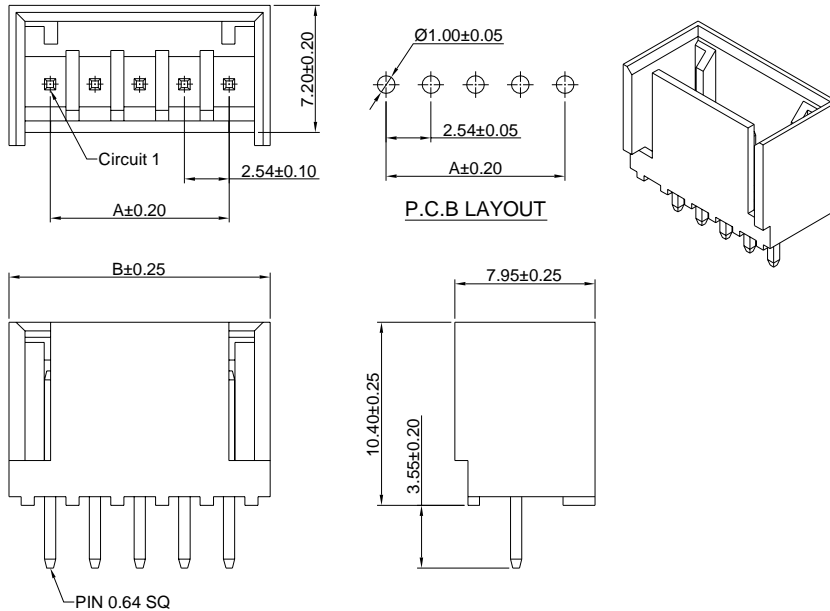

D2541WV-F

2.54mm IDC 180° Wafer

Reference Informations:

- *Material:Pin:Brass/Tin over Nickel
Insulator:PBT,UL94V-0
- *Mates with D2541 series Housing
- *Color:Black

Ordering Information:

- D2541WV-F-XP - *
1 2
- 1.Part No.
 - 2.Finish:
(Blank):Brass/Tin over Nickel
G:Brass/Gold over Nickel

Ordering Information & Dimensions:

PART NO.	Dimensions	
	A	B
D2541WV-F-2P	2.54	7.21
D2541WV-F-3P	5.08	9.75
D2541WV-F-4P	7.62	12.29
D2541WV-F-5P	10.16	14.83
D2541WV-F-6P	12.70	17.37
D2541WV-F-7P	15.24	19.91
D2541WV-F-8P	17.78	22.45
D2541WV-F-9P	20.32	24.99
D2541WV-F-10P	22.86	27.53
D2541WV-F-11P	25.40	30.07
D2541WV-F-12P	27.94	32.61
D2541WV-F-13P	30.48	35.15
D2541WV-F-14P	32.02	37.69
D2541WV-F-15P	35.56	40.23
D2541WV-F-16P	38.10	42.77
D2541WV-F-17P	40.64	45.31
D2541WV-F-18P	43.18	47.85
D2541WV-F-19P	45.72	50.39
D2541WV-F-20P	48.26	52.93
D2541WV-F-21P	50.80	55.47
D2541WV-F-22P	53.34	58.01
D2541WV-F-23P	55.88	60.55
D2541WV-F-24P	58.42	63.09

Unit: mm

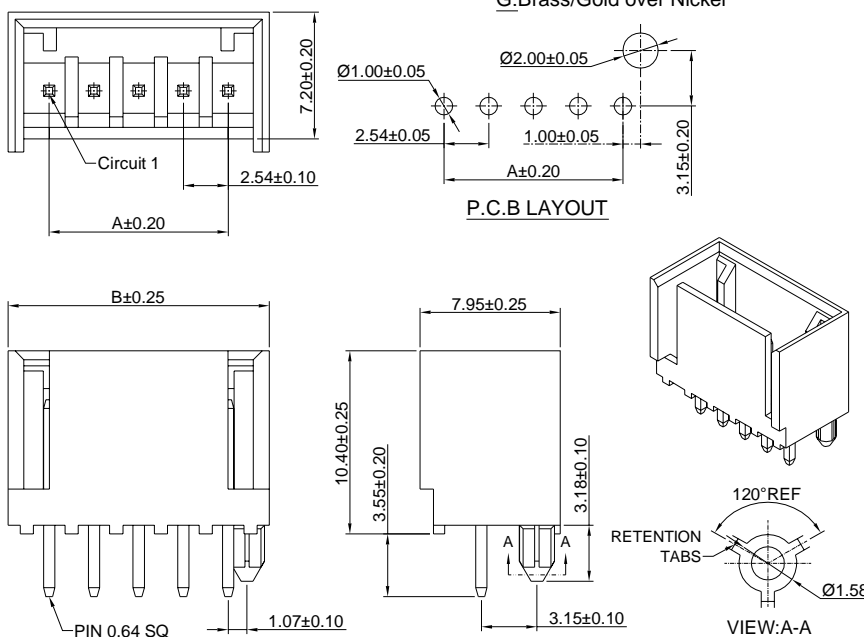

D2541 SERIES

2.54mm pitch IDC wire to board connector

D2541C

2.54mm Feed-Thru Strain Relief Covers

Reference Informations:

- *Material:Nylon66,UL 94V-0
- *Mates with D2541 series Housing
- *Color:Natural(White)

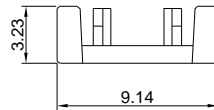
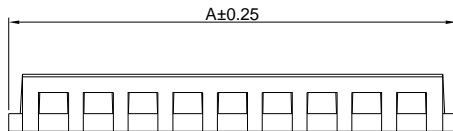
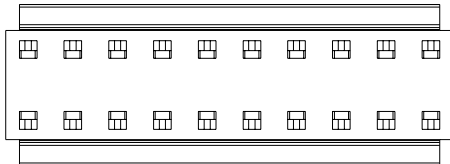

Ordering Information & Dimensions:

PART NO.	Dim.A
D2541C-2P	5.08
D2541C-3P	7.62
D2541C-4P	10.16
D2541C-5P	12.70
D2541C-6P	15.24
D2541C-7P	17.78
D2541C-8P	20.32
D2541C-9P	22.86
D2541C-10P	25.40
D2541C-11P	27.94
D2541C-12P	30.48
D2541C-13P	33.02
D2541C-14P	35.56
D2541C-15P	38.10
D2541C-16P	40.64
D2541C-17P	43.18
D2541C-18P	45.72
D2541C-19P	48.26
D2541C-20P	50.80
D2541C-21P	53.34
D2541C-22P	55.88
D2541C-23P	58.42
D2541C-24P	60.96

Unit: mm

D2541L

2.54mm IDC Closed End Strain Relief Covers

Reference Informations:

- *Material:Nylon66,UL 94V-0
- *Mates with D2541 series Housing
- *Color:Natural(White)

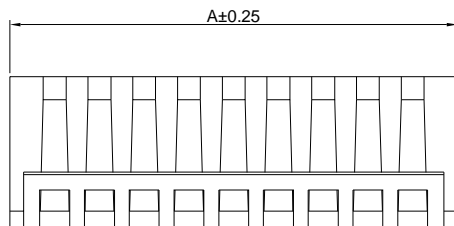
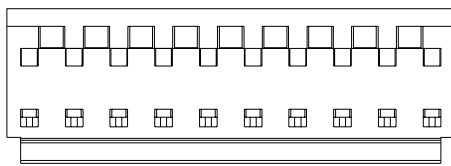

Ordering Information & Dimensions:

PART NO.	Dim.A
D2541L-2P	5.08
D2541L-3P	7.62
D2541L-4P	10.16
D2541L-5P	12.70
D2541L-6P	15.24
D2541L-7P	17.78
D2541L-8P	20.32
D2541L-9P	22.86
D2541L-10P	25.40
D2541L-11P	27.94
D2541L-12P	30.48
D2541L-13P	33.02
D2541L-14P	35.56
D2541L-15P	38.10
D2541L-16P	40.64
D2541L-17P	43.18
D2541L-18P	45.72
D2541L-19P	48.26
D2541L-20P	50.80
D2541L-21P	53.34
D2541L-22P	55.88
D2541L-23P	58.42
D2541L-24P	60.96

Unit: mm

D2541 SERIES

2.54mm pitch IDC wire to board connector

D2541WR

2.54mm IDC 90° Wafer

Reference Informations:

- *Material:Pin:Brass/Tin over Nickel
Insulator:PBT,UL94V-0
- *Mates with D2541 series Housing
- *Color:Black

Ordering Information:

- D2541WR-XP - *
1 2
- 1.Part No.
 - 2.Finish:
(Blank):Brass/Tin over Nickel
G:Brass/Gold over Nickel

Ordering Information & Dimensions:

PART NO.	Dimensions	
	A	B
D2541WR-2P	2.54	7.21
D2541WR-3P	5.08	9.75
D2541WR-4P	7.62	12.29
D2541WR-5P	10.16	14.83
D2541WR-6P	12.70	17.37
D2541WR-7P	15.24	19.91
D2541WR-8P	17.78	22.45
D2541WR-9P	20.32	24.99
D2541WR-10P	22.86	27.53
D2541WR-11P	25.40	30.07
D2541WR-12P	27.94	32.61
D2541WR-13P	30.48	35.15
D2541WR-14P	32.02	37.69
D2541WR-15P	35.56	40.23
D2541WR-16P	38.10	42.77
D2541WR-17P	40.64	45.31
D2541WR-18P	43.18	47.85
D2541WR-19P	45.72	50.39
D2541WR-20P	48.26	52.93
D2541WR-21P	50.80	55.47
D2541WR-22P	53.34	58.01
D2541WR-23P	55.88	60.55
D2541WR-24P	58.42	63.09

Unit: mm

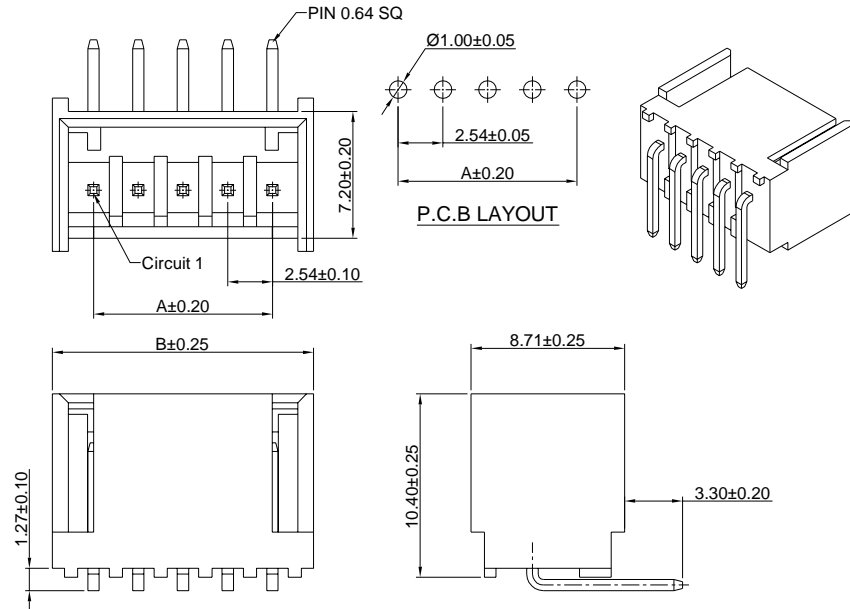

D2541WR-2

2.54mm IDC 90° Wafer

Reference Informations:

- *Material:Pin:Brass/Tin over Nickel
Insulator:PBT,UL94V-0
- *Mates with D2541 series Housing
- *Color:Black

Ordering Information:

- D2541WR-XP-2 - *
1 2
- 1.Part No.
 - 2.Finish:
(Blank):Brass/Tin over Nickel
G:Brass/Gold over Nickel

Ordering Information & Dimensions:

PART NO.	Dimensions	
	A	B
D2541WR-2P-2	2.54	7.21
D2541WR-3P-2	5.08	9.75
D2541WR-4P-2	7.62	12.29
D2541WR-5P-2	10.16	14.83
D2541WR-6P-2	12.70	17.37
D2541WR-7P-2	15.24	19.91
D2541WR-8P-2	17.78	22.45
D2541WR-9P-2	20.32	24.99
D2541WR-10P-2	22.86	27.53
D2541WR-11P-2	25.40	30.07
D2541WR-12P-2	27.94	32.61
D2541WR-13P-2	30.48	35.15
D2541WR-14P-2	32.02	37.69
D2541WR-15P-2	35.56	40.23
D2541WR-16P-2	38.10	42.77
D2541WR-17P-2	40.64	45.31
D2541WR-18P-2	43.18	47.85
D2541WR-19P-2	45.72	50.39
D2541WR-20P-2	48.26	52.93
D2541WR-21P-2	50.80	55.47
D2541WR-22P-2	53.34	58.01
D2541WR-23P-2	55.88	60.55
D2541WR-24P-2	58.42	63.09

Unit: mm

