

# A1002 SERIES

1.00mm pitch wire to board connector

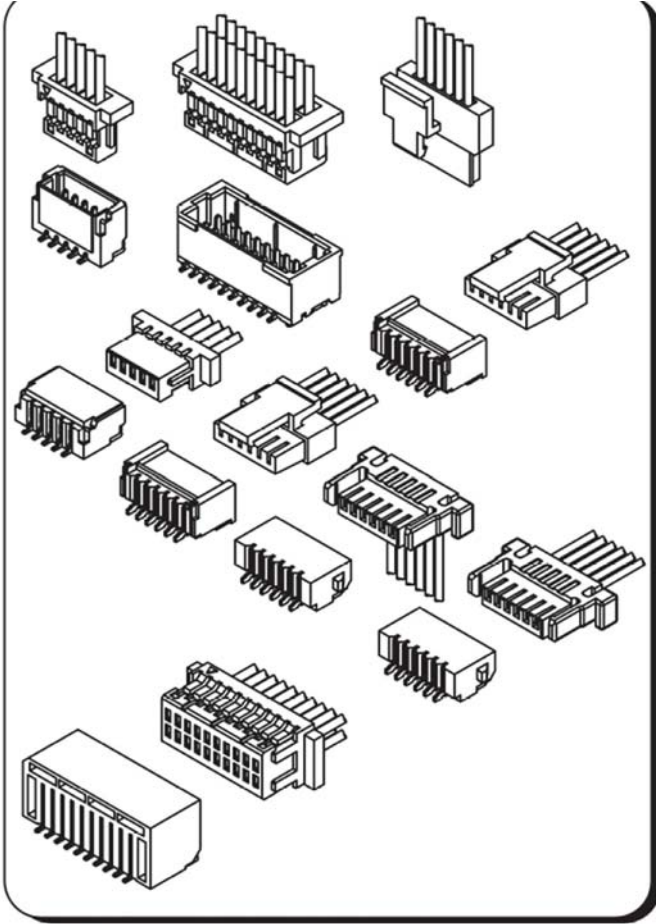

## Specifications

- Current rating: 1A AC,DC
- Voltage rating: 50V AC,DC
- Temperature range: -40°C~+105°C
- Contact resistance: 20mΩMax.
- Insulation resistance: 100MΩMin.
- Withstanding voltage: 500V AC/minute
- \*Compliant with RoHS and REACH\*
- \*Meet the HF/Halogen Free, need to customize\*
- \*Contact JSV for details\*

## Standards



## (Assembly layout)

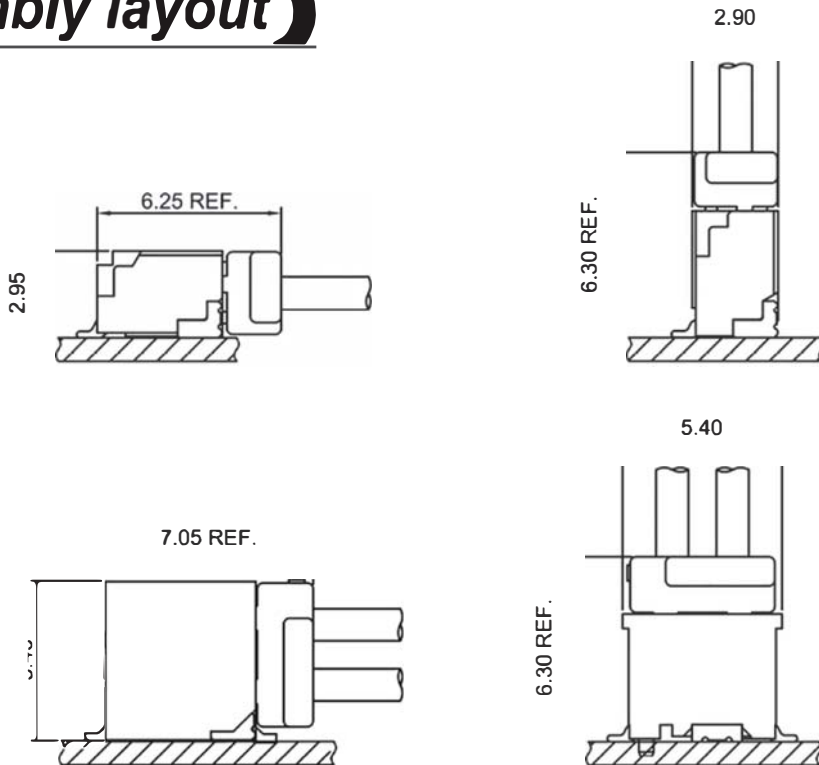

# A1002 SERIES

1.00mm pitch wire to board connector

## A1002H-T

—1.00mm pitch Crimp Terminal—

### Reference Informations:

\*Used in JSV A1002H , A1002HJ , A1002H-2 series Housing

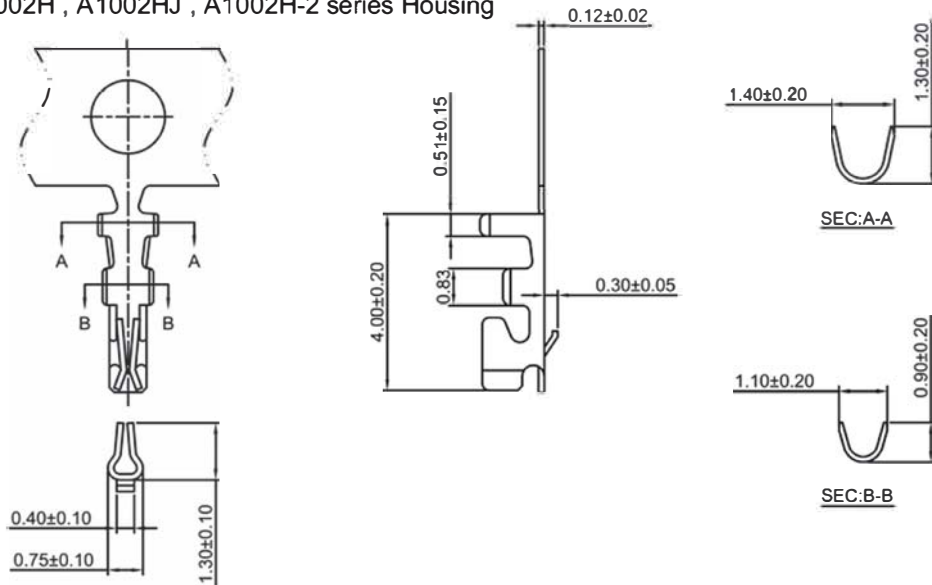

Ordering information & Specifications:

Unit:mm

Part NO.	Wire Range	Insulation O.D.	Material	Finish	Qty/reel
A1002H-TP	AWG#28-#32	0.80mm(max)	Phosphor Bronze	Tin over Nickel	20,000 PCS
A1002H-GP	AWG#28-#32	0.80mm(max)	Phosphor Bronze	Gold over flash	20,000 PCS

Optional Gold plating available but MOQ requested

## A1002A-T

—1.00mm pitch Crimp Terminal—

### Reference Informations:

\*Used in JSV A1002HA , A1002HB , A1002HE series Housing

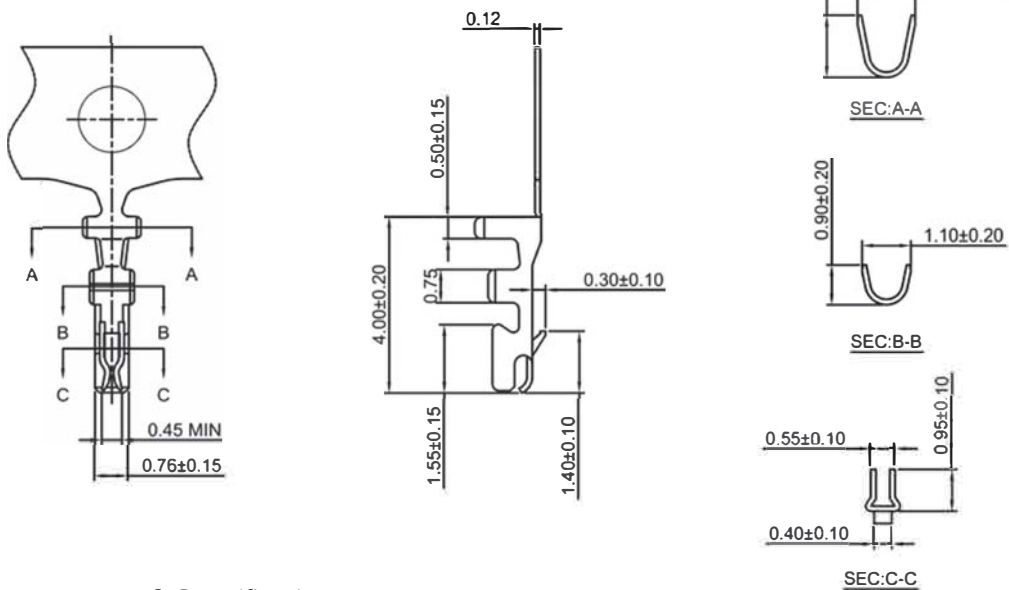

Ordering information & Specifications:

Unit:mm

Part NO.	Wire Range	Insulation O.D.	Material	Finish	Qty/reel
A1002A-TP	AWG#28-#32	0.80mm(max)	Phosphor Bronze	Tin over Nickel	20,000 PCS
A1002A-GP	AWG#28-#32	0.80mm(max)	Phosphor Bronze	Gold over flash	20,000 PCS

Optional Gold plating available but MOQ requested

# A1002 SERIES

1.00mm pitch wire to board connector

## A1002C-T

—1.00mm pitch Crimp Terminal—

### Reference Informations:

\*Used in JSV A1002HC , A1002HD series Housing

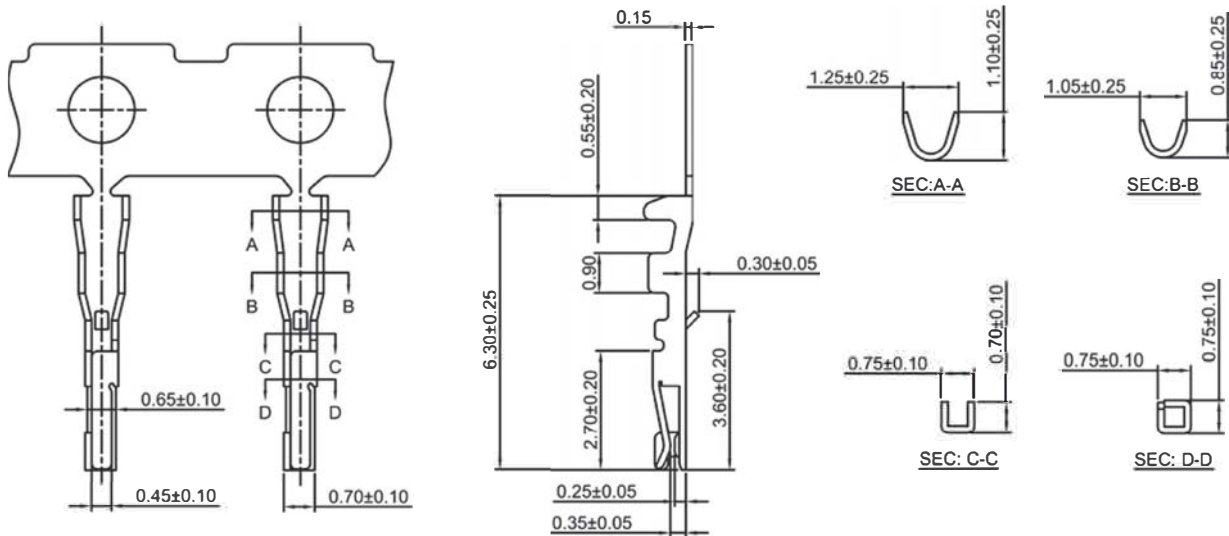

Ordering information & Specifications:

Unit:mm

Part NO.	Wire Range	Insulation O.D.	Material	Finish	Qty/reel
A1002C-TP	AWG#28-#32	0.80mm(max)	Phosphor Bronze	Tin over Nickel	20,000 PCS
A1002C-GP	AWG#28-#32	0.80mm(max)	Phosphor Bronze	Gold over flash	20,000 PCS

Optional Gold plating available but MOQ requested

## A1002D-T

—1.00mm pitch Crimp Terminal—

### Reference Informations:

\*Used in JSV A1002HG , A1002HI series Housing

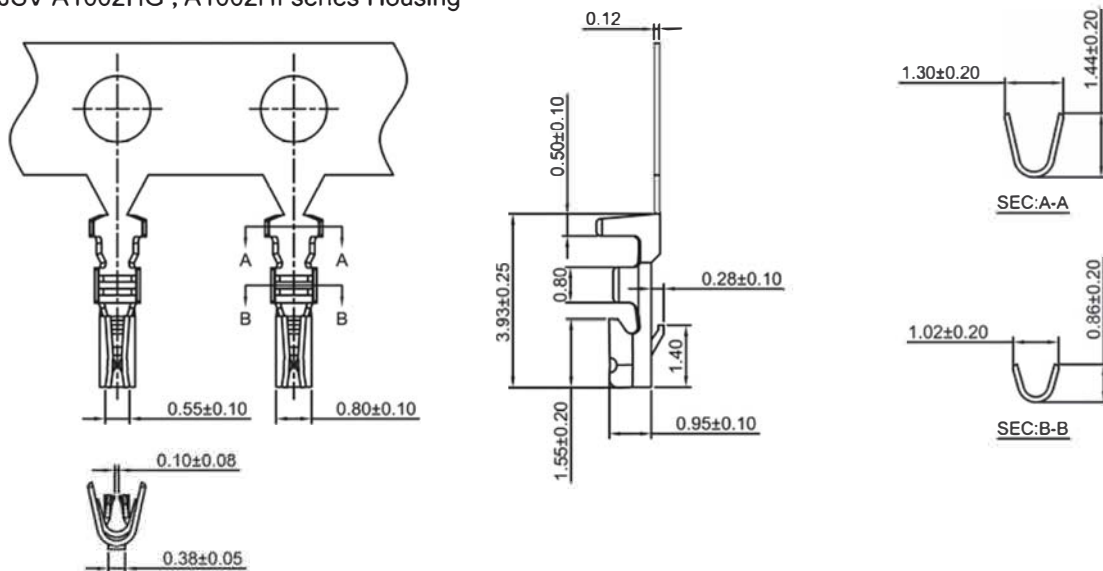

Ordering information & Specifications:

Unit:mm

Part NO.	Wire Range	Insulation O.D.	Material	Finish	Qty/reel
A1002D-TP	AWG#28-#32	0.80mm(max)	Phosphor Bronze	Tin over Nickel	20,000 PCS
A1002D-GP	AWG#28-#32	0.80mm(max)	Phosphor Bronze	Gold over flash	20,000 PCS

Optional Gold plating available but MOQ requested

# A1002 SERIES

1.00mm pitch wire to board connector

## A1002H

1.00mm pitch Single Row Housing

### Reference Informations:

- \*Material:PBT,UL94V-0
- \*Suitable JSV A1002H-T series Terminal
- \*Mates with JSV A1002WV-S , A1002WR-S series Wafer
- \*Color:White

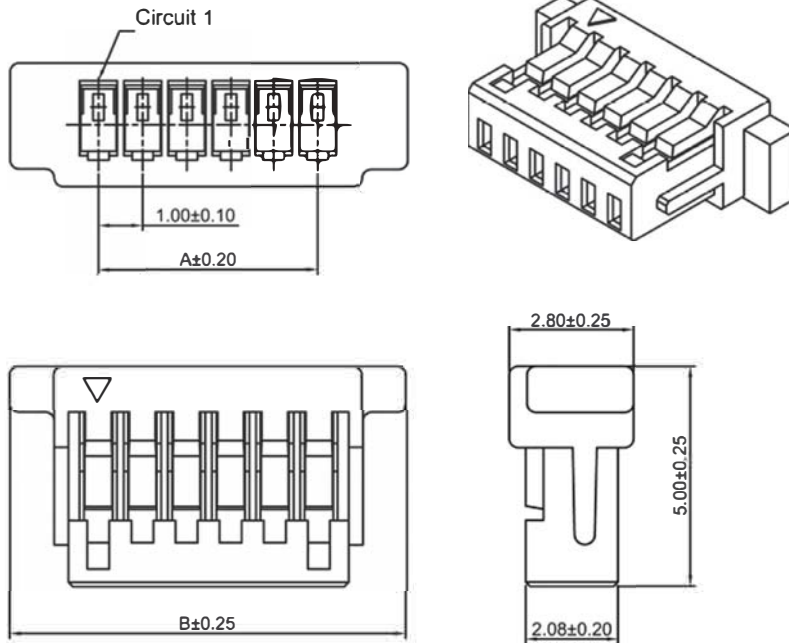

### Ordering Information & Dimensions:

PART NO.	Dimensions	
	A	B
A1002H-02P	1.00	5.00
A1002H-03P	2.00	6.00
A1002H-04P	3.00	7.00
A1002H-05P	4.00	8.00
A1002H-06P	5.00	9.00
A1002H-07P	6.00	10.00
A1002H-08P	7.00	11.00
A1002H-09P	8.00	12.00
A1002H-10P	9.00	13.00
A1002H-11P	10.00	14.00
A1002H-12P	11.00	15.00
A1002H-13P	12.00	16.00
A1002H-14P	13.00	17.00
A1002H-15P	14.00	18.00
A1002H-16P	15.00	19.00
A1002H-17P	16.00	20.00
A1002H-18P	17.00	21.00
A1002H-19P	18.00	22.00
A1002H-20P	19.00	23.00

Unit: mm

## A1002HJ

1.00mm pitch Single Row Housing

### Reference Informations:

- \*Material:PBT,UL94V-0
- \*Suitable JSV A1002H-T series Terminal
- \*Mates with JSV A1002WV-S , A1002WR-S series Wafer
- \*Color:White

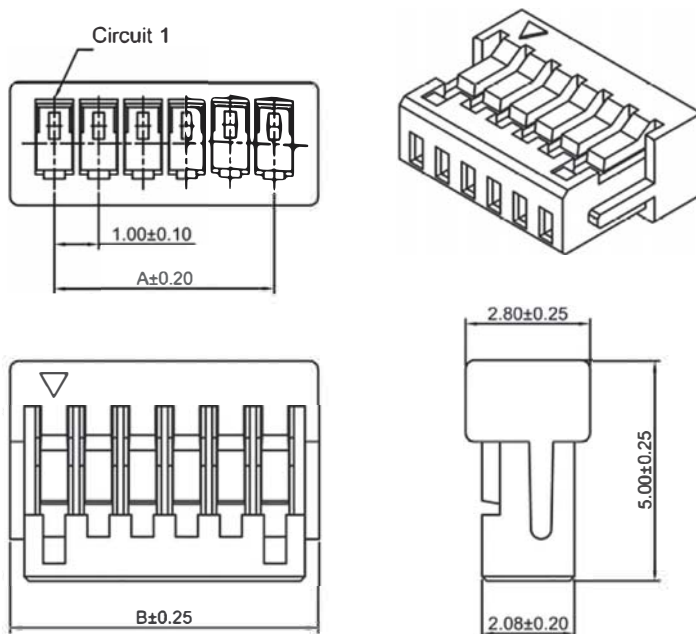

### Ordering Information & Dimensions:

PART NO.	Dimensions	
	A	B
A1002HJ-02P	1.00	3.00
A1002HJ-03P	2.00	4.00
A1002HJ-04P	3.00	5.00
A1002HJ-05P	4.00	6.00
A1002HJ-06P	5.00	7.00
A1002HJ-07P	6.00	8.00
A1002HJ-08P	7.00	9.00
A1002HJ-09P	8.00	10.00
A1002HJ-10P	9.00	11.00
A1002HJ-11P	10.00	12.00
A1002HJ-12P	11.00	13.00
A1002HJ-13P	12.00	14.00
A1002HJ-14P	13.00	15.00
A1002HJ-15P	14.00	16.00
A1002HJ-16P	15.00	17.00
A1002HJ-17P	16.00	18.00
A1002HJ-18P	17.00	19.00
A1002HJ-19P	18.00	20.00
A1002HJ-20P	19.00	21.00

# A1002 SERIES

1.00mm pitch wire to board connector

## A1002HA

1.00mm pitch Single Row Housing

### Reference Informations:

- \*Material:PBT,UL94V-0
- \*Suitable JSV A1002A-T series Terminal
- \*Mates with JSV A1002WVB-S , A1002WRA-S , A1002WRB-S series Wafer
- \*Color:White

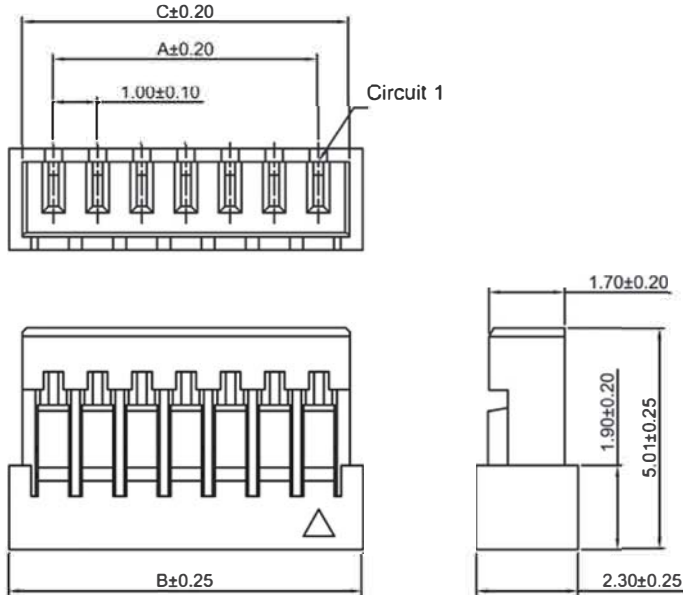
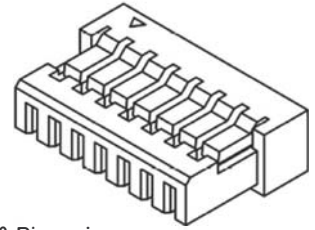

Ordering Information & Dimensions:

PART NO.	Dimensions		
	A	B	C
A1002HA-02P	1.00	3.00	2.40
A1002HA-03P	2.00	4.00	3.40
A1002HA-04P	3.00	5.00	4.40
A1002HA-05P	4.00	6.00	5.40
A1002HA-06P	5.00	7.00	6.40
A1002HA-07P	6.00	8.00	7.40
A1002HA-08P	7.00	9.00	8.40
A1002HA-09P	8.00	10.00	9.40
A1002HA-10P	9.00	11.00	10.40
A1002HA-11P	10.00	12.00	11.40
A1002HA-12P	11.00	13.00	12.40
A1002HA-13P	12.00	14.00	13.40
A1002HA-14P	13.00	15.00	14.40
A1002HA-15P	14.00	16.00	15.40
A1002HA-16P	15.00	17.00	16.40
A1002HA-17P	16.00	18.00	17.40
A1002HA-18P	17.00	19.00	18.40
A1002HA-19P	18.00	20.00	19.40
A1002HA-20P	19.00	21.00	20.40

Unit:mm

## A1002HB

1.00mm pitch Single Row Housing

### Reference Informations:

- \*Material:Nylon 66,UL94V-0
- \*Suitable JSV A1002A-T series Terminal
- \*Mates with JSV A1002WVB-S , A1002WRB-S series Wafer
- \*Color:White

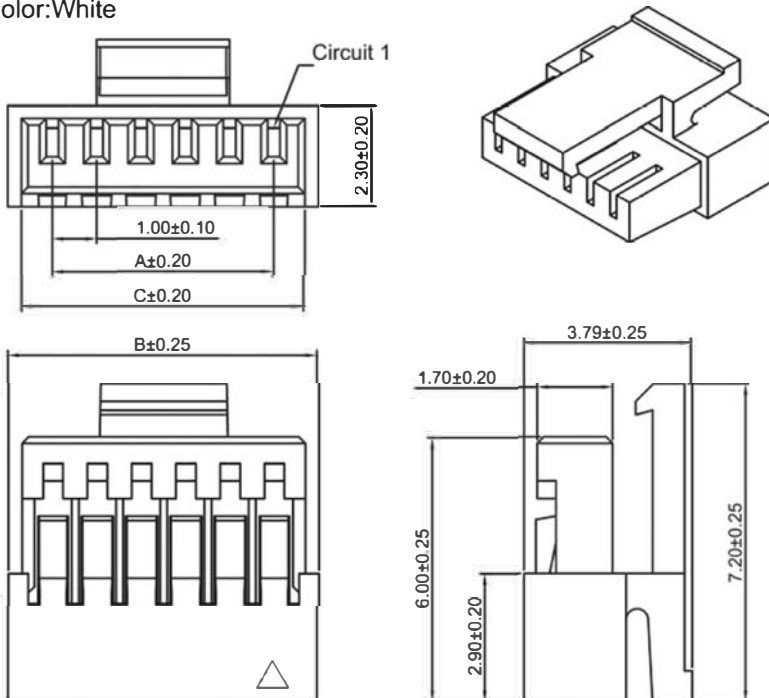

Ordering Information & Dimensions:

PART NO.	Dimensions		
	A	B	C
A1002HB-02P	1.00	3.00	2.40
A1002HB-03P	2.00	4.00	3.40
A1002HB-04P	3.00	5.00	4.40
A1002HB-05P	4.00	6.00	5.40
A1002HB-06P	5.00	7.00	6.40
A1002HB-07P	6.00	8.00	7.40
A1002HB-08P	7.00	9.00	8.40
A1002HB-09P	8.00	10.00	9.40
A1002HB-10P	9.00	11.00	10.40
A1002HB-11P	10.00	12.00	11.40
A1002HB-12P	11.00	13.00	12.40
A1002HB-13P	12.00	14.00	13.40
A1002HB-14P	13.00	15.00	14.40
A1002HB-15P	14.00	16.00	15.40
A1002HB-16P	15.00	17.00	16.40
A1002HB-17P	16.00	18.00	17.40
A1002HB-18P	17.00	19.00	18.40
A1002HB-19P	18.00	20.00	19.40
A1002HB-20P	19.00	21.00	20.40

Unit:mm



# A1002 SERIES

1.00mm pitch wire to board connector

## A1002HC

1.00mm pitch Single Row Housing

### Reference Informations:

\*Material:Nylon 46,UL94V-0

\*Suitable JSV A1002C-T series Terminal

\*Color:Ivory

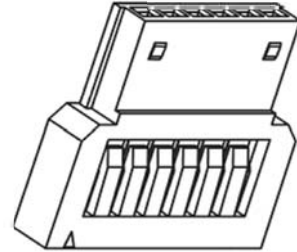
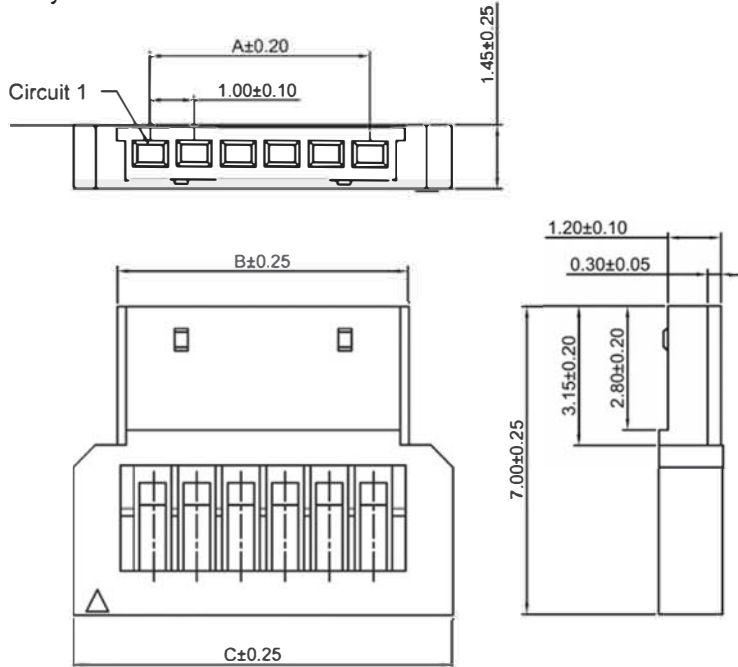

Ordering Information & Dimensions:

PART NO.	Dimensions		
	A	B	C
A1002HC-04P	3.00	4.60	6.60
A1002HC-06P	5.00	6.60	8.60

Unit:mm

## A1002HD

1.00mm pitch Single Row Housing

### Reference Informations:

\*Material:Nylon 46,UL94V-0

\*Suitable JSV A1002C-T series Terminal

\*Color:Ivory

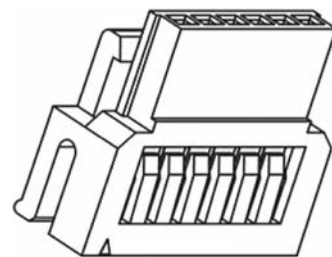
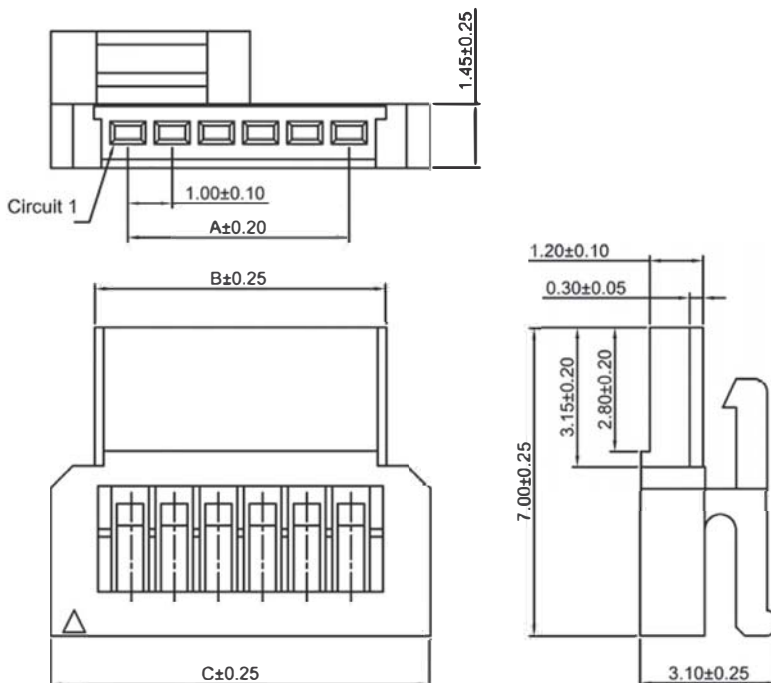

Ordering Information & Dimensions:

PART NO.	Dimensions		
	A	B	C
A1002HD-04P	3.00	4.60	6.60
A1002HD-06P	5.00	6.60	8.60

Unit:mm

# A1002 SERIES

1.00mm pitch wire to board connector

## A1002HE

1.00mm pitch Single Row Housing

### Reference Informations:

- \*Material:Nylon 66,UL94V-0
- \*Suitable JSV A1002A-T series Terminal
- \*Mates with JSV A1002WRC-S series Wafer
- \*Color:White

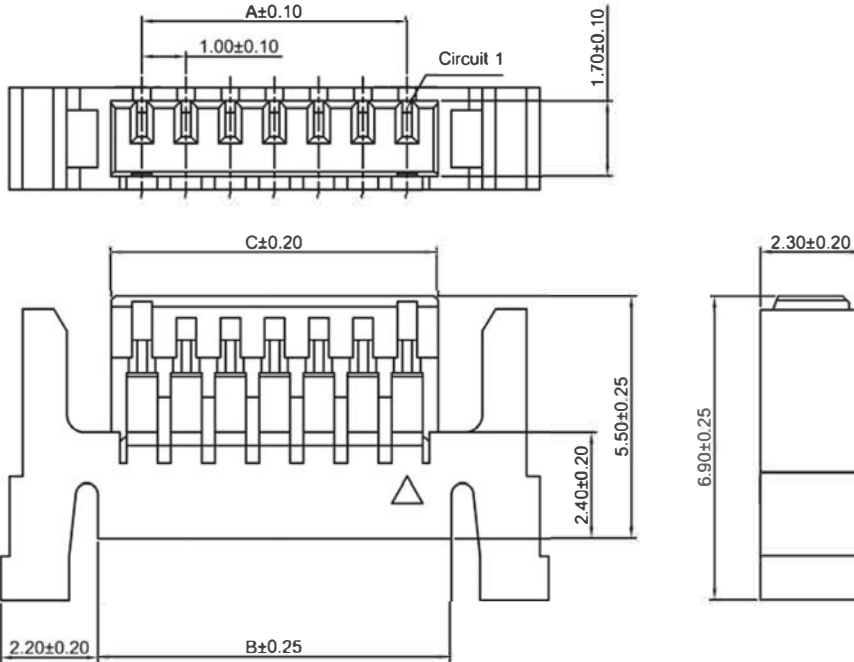

### Ordering Information & Dimensions:

PART NO.	Dimensions		
	A	B	C
A1002HE-02P	1.00	3.00	2.40
A1002HE-03P	2.00	4.00	3.40
A1002HE-04P	3.00	5.00	4.40
A1002HE-05P	4.00	6.00	5.40
A1002HE-06P	5.00	7.00	6.40
A1002HE-07P	6.00	8.00	7.40
A1002HE-08P	7.00	9.00	8.40
A1002HE-09P	8.00	10.00	9.40
A1002HE-10P	9.00	11.00	10.40
A1002HE-11P	10.00	12.00	11.40
A1002HE-12P	11.00	13.00	12.40
A1002HE-13P	12.00	14.00	13.40
A1002HE-14P	13.00	15.00	14.40
A1002HE-15P	14.00	16.00	15.40
A1002HE-16P	15.00	17.00	16.40
A1002HE-17P	16.00	18.00	17.40
A1002HE-18P	17.00	19.00	18.40
A1002HE-19P	18.00	20.00	19.40
A1002HE-20P	19.00	21.00	20.40

Unit:mm

## A1002HG

1.00mm pitch 180° Single Row Housing

### Reference Informations:

- \*Material:Nylon 66,UL94V-0
- \*Suitable JSV A1002D-T series Terminal
- \*Mates with JSV A1002WRD-S series Wafer
- \*Color:White

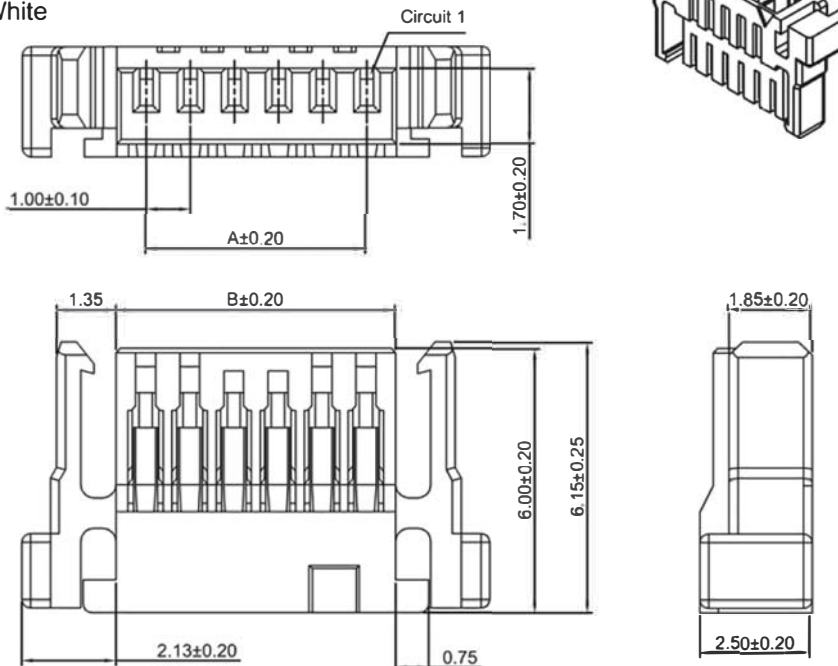

### Ordering Information & Dimensions:

PART NO.	Dimensions	
	A	B
A1002HG-02P	1.00	2.30
A1002HG-03P	2.00	3.30
A1002HG-04P	3.00	4.30
A1002HG-05P	4.00	5.30
A1002HG-06P	5.00	6.30
A1002HG-07P	6.00	7.30
A1002HG-08P	7.00	8.30
A1002HG-09P	8.00	9.30
A1002HG-10P	9.00	10.30
A1002HG-11P	10.00	11.30
A1002HG-12P	11.00	12.30
A1002HG-13P	12.00	13.30
A1002HG-14P	13.00	14.30
A1002HG-15P	14.00	15.30
A1002HG-16P	15.00	16.30
A1002HG-17P	16.00	17.30
A1002HG-18P	17.00	18.30
A1002HG-19P	18.00	19.30
A1002HG-20P	19.00	20.30

# A1002 SERIES

1.00mm pitch wire to board connector

## A1002HI

1.00mm pitch 90° Single Row Housing

### Reference Informations:

- \*Material:Nylon 66,UL94V-0
- \*Suitable JSV A1002D-T series Terminal
- \*Mates with JSV A1002WRD-S series Wafer
- \*Color:White

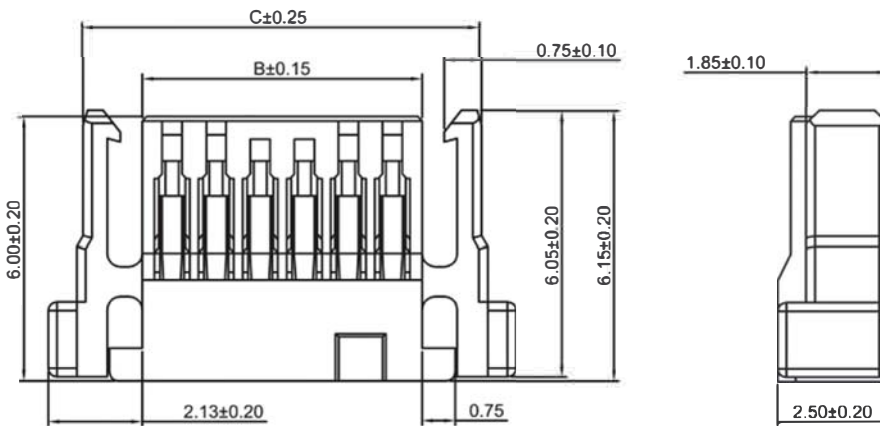
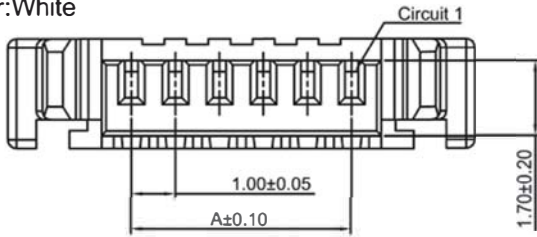
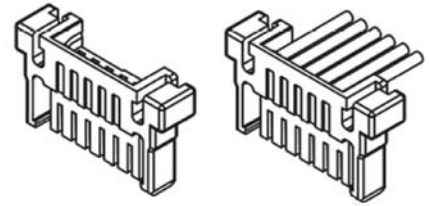

Ordering Information & Dimensions:

PART NO.	Dimensions	
	A	B
A1002HI-02P	1.00	2.30
A1002HI-03P	2.00	3.30
A1002HI-04P	3.00	4.30
A1002HI-05P	4.00	5.30
A1002HI-06P	5.00	6.30
A1002HI-07P	6.00	7.30
A1002HI-08P	7.00	8.30
A1002HI-09P	8.00	9.30
A1002HI-10P	9.00	10.30
A1002HI-11P	10.00	11.30
A1002HI-12P	11.00	12.30
A1002HI-13P	12.00	13.30
A1002HI-14P	13.00	14.30
A1002HI-15P	14.00	15.30
A1002HI-16P	15.00	16.30
A1002HI-17P	16.00	17.30
A1002HI-18P	17.00	18.30
A1002HI-19P	18.00	19.30
A1002HI-20P	19.00	20.30

Unit:mm

## A1002HL

1.00mm pitch 90° Single Row Wafer - SMT TYPE

### Reference Informations:

- \*Material:Nylon 66,UL94V-0
- \*Suitable JSV A1002H series Terminal
- \*Mates with JSV A1002 series Single Row Wafer
- \*Color:Natural

Ordering Information:

A1002HL-NP-□-□-□-□  
1 2 3 4

- Material:  
0=Nylon 66,UL94V-0
- Color code:  
NA:Natural
- Client code

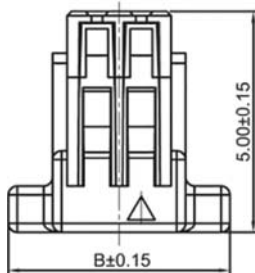
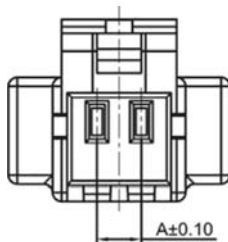

Ordering Information & Dimensions:

PART NO.	Dimensions	
	A	B
A1002HL-02P	1.00	5.00
A1002HL-03P	2.00	6.00
A1002HL-04P	3.00	7.00
A1002HL-05P	4.00	8.00
A1002HL-06P	5.00	9.00
A1002HL-07P	6.00	10.00
A1002HL-08P	7.00	11.00
A1002HL-09P	8.00	12.00
A1002HL-10P	9.00	13.00
A1002HL-11P	10.00	14.00
A1002HL-12P	11.00	15.00

Unit:mm



# A1002 SERIES

1.00mm pitch wire to board connector

## A1002WV-S

1.00mm pitch 180° Single Row Wafer - SMT TYPE

### Reference Informations:

- \*Material: Pin: Phosphor Bronze/Tin over Nickel  
Solder Tabs: Phosphor Bronze/Tin over Nickel  
Insulator: Nylon 6T, UL94V-0
- \*Mates with JSV A1002H, A1002HJ series Housing
- \*Color: Ivory

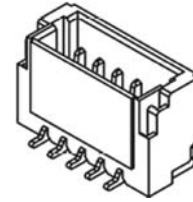

Ordering Information & Dimensions:

PART NO.	Dimensions	
	A	B
A1002WV-S-02P	1.00	4.00
A1002WV-S-03P	2.00	5.00
A1002WV-S-04P	3.00	6.00
A1002WV-S-05P	4.00	7.00
A1002WV-S-06P	5.00	8.00
A1002WV-S-07P	6.00	9.00
A1002WV-S-08P	7.00	10.00
A1002WV-S-09P	8.00	11.00
A1002WV-S-10P	9.00	12.00
A1002WV-S-11P	10.00	13.00
A1002WV-S-12P	11.00	14.00
A1002WV-S-13P	12.00	15.00
A1002WV-S-14P	13.00	16.00
A1002WV-S-15P	14.00	17.00
A1002WV-S-16P	15.00	18.00
A1002WV-S-17P	16.00	19.00
A1002WV-S-18P	17.00	20.00
A1002WV-S-19P	18.00	21.00
A1002WV-S-20P	19.00	22.00

Unit: mm

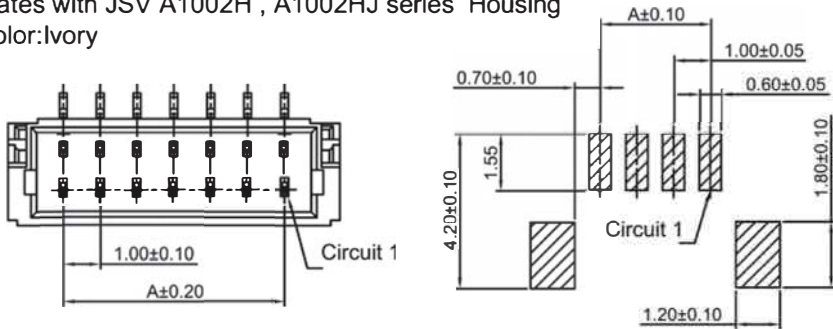

P.C.B LAYOUT



## A1002WR-S

1.00mm pitch 90° Single Row Wafer - SMT TYPE

### Reference Informations:

- \*Material: Pin: Phosphor Bronze/Tin over Nickel  
Solder Tabs: Phosphor Bronze/Tin over Nickel  
Insulator: Nylon 6T, UL94V-0
- \*Mates with JSV A1002H, A1002HJ series Housing
- \*Color: Ivory

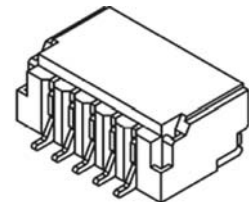

Ordering Information & Dimensions:

PART NO.	Dimensions	
	A	B
A1002WR-S-02P	1.00	4.00
A1002WR-S-03P	2.00	5.00
A1002WR-S-04P	3.00	6.00
A1002WR-S-05P	4.00	7.00
A1002WR-S-06P	5.00	8.00
A1002WR-S-07P	6.00	9.00
A1002WR-S-08P	7.00	10.00
A1002WR-S-09P	8.00	11.00
A1002WR-S-10P	9.00	12.00
A1002WR-S-11P	10.00	13.00
A1002WR-S-12P	11.00	14.00
A1002WR-S-13P	12.00	15.00
A1002WR-S-14P	13.00	16.00
A1002WR-S-15P	14.00	17.00
A1002WR-S-16P	15.00	18.00
A1002WR-S-17P	16.00	19.00
A1002WR-S-18P	17.00	20.00
A1002WR-S-19P	18.00	21.00
A1002WR-S-20P	19.00	22.00

Unit: mm

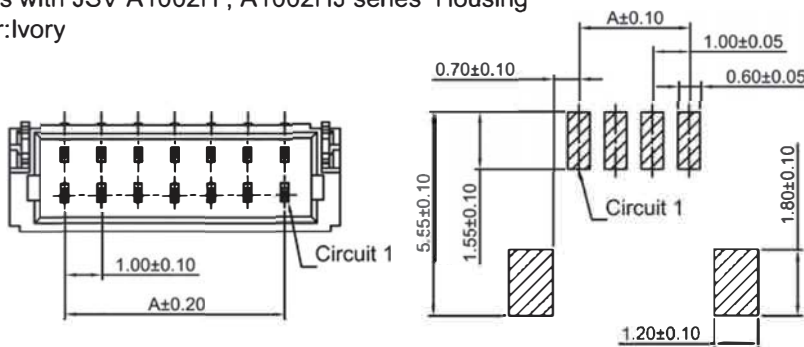

P.C.B LAYOUT

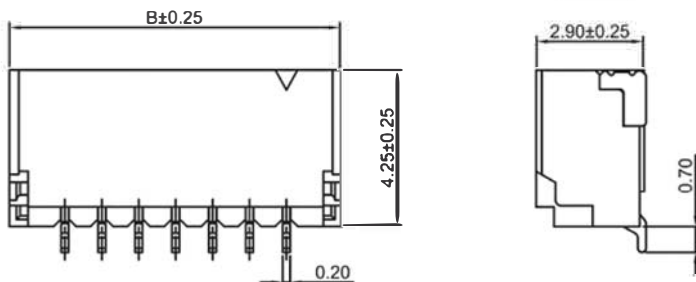

# A1002 SERIES

1.00mm pitch wire to board connector

## A1002WVB-S

1.00mm pitch 180° Single Row Wafer - SMT TYPE

### Reference Informations:

- \*Material:Pin:Phosphor Bronze/Tin over Nickel  
Solder Tabs: Phosphor Bronze/Tin over Nickel  
Insulator:Nylon 9T,UL94V-0
- \*Mates with JSV A1002HA , A1002HB series Housing
- \*Color:Ivory

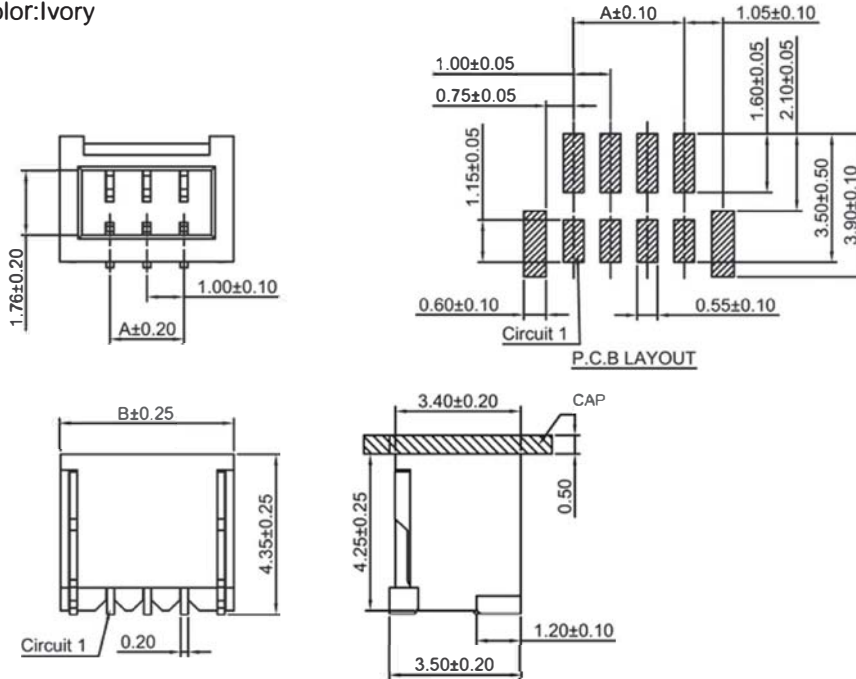
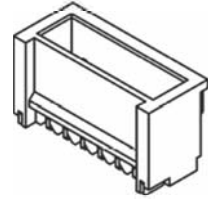

Ordering Information & Dimensions:

PART NO.	Dimensions	
	A	B
A1002WVB-S-02P	1.00	3.70
A1002WVB-S-03P	2.00	4.70
A1002WVB-S-04P	3.00	5.70
A1002WVB-S-05P	4.00	6.70
A1002WVB-S-06P	5.00	7.70
A1002WVB-S-07P	6.00	8.70
A1002WVB-S-08P	7.00	9.70
A1002WVB-S-09P	8.00	10.70
A1002WVB-S-10P	9.00	11.70
A1002WVB-S-11P	10.00	12.70
A1002WVB-S-12P	11.00	13.70
A1002WVB-S-13P	12.00	14.70
A1002WVB-S-14P	13.00	15.70
A1002WVB-S-15P	14.00	16.70
A1002WVB-S-16P	15.00	17.70
A1002WVB-S-17P	16.00	18.70
A1002WVB-S-18P	17.00	19.70
A1002WVB-S-19P	18.00	20.70
A1002WVB-S-20P	19.00	21.70

Unit: mm

## A1002WRB-S

1.00mm pitch 90° Single Row Wafer - SMT TYPE

### Reference Informations:

- \*Material:Pin:Phosphor Bronze/Tin over Nickel  
Solder Tabs: Phosphor Bronze/Tin over Nickel  
Insulator:Nylon 9T,UL94V-0
- \*Mates with JSV A1002HA , A1002HB series Housing
- \*Color:Ivory

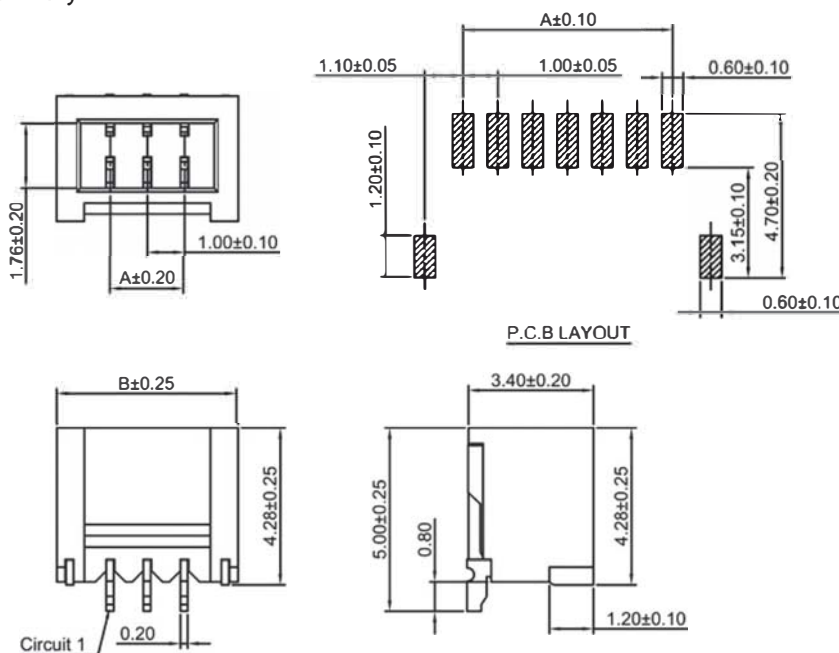
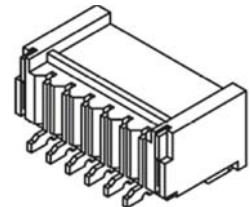

Ordering Information & Dimensions:

PART NO.	Dimensions	
	A	B
A1002WRB-S-02P	1.00	3.70
A1002WRB-S-03P	2.00	4.70
A1002WRB-S-04P	3.00	5.70
A1002WRB-S-05P	4.00	6.70
A1002WRB-S-06P	5.00	7.70
A1002WRB-S-07P	6.00	8.70
A1002WRB-S-08P	7.00	9.70
A1002WRB-S-09P	8.00	10.70
A1002WRB-S-10P	9.00	11.70
A1002WRB-S-11P	10.00	12.70
A1002WRB-S-12P	11.00	13.70
A1002WRB-S-13P	12.00	14.70
A1002WRB-S-14P	13.00	15.70
A1002WRB-S-15P	14.00	16.70
A1002WRB-S-16P	15.00	17.70
A1002WRB-S-17P	16.00	18.70
A1002WRB-S-18P	17.00	19.70
A1002WRB-S-19P	18.00	20.70
A1002WRB-S-20P	19.00	21.70

Unit: mm

# A1002 SERIES

1.00mm pitch wire to board connector

## A1002WRC-S

1.00mm pitch 90° Single Row Wafer - SMT TYPE

### Reference Informations:

- \*Material: Pin: Brass/Tin over Nickel  
Solder Tabs: Brass/Tin over Nickel  
Insulator: Nylon 9T, UL94V-0
- \*Mates with JSV A1002HE series Housing
- \*Color: Ivory

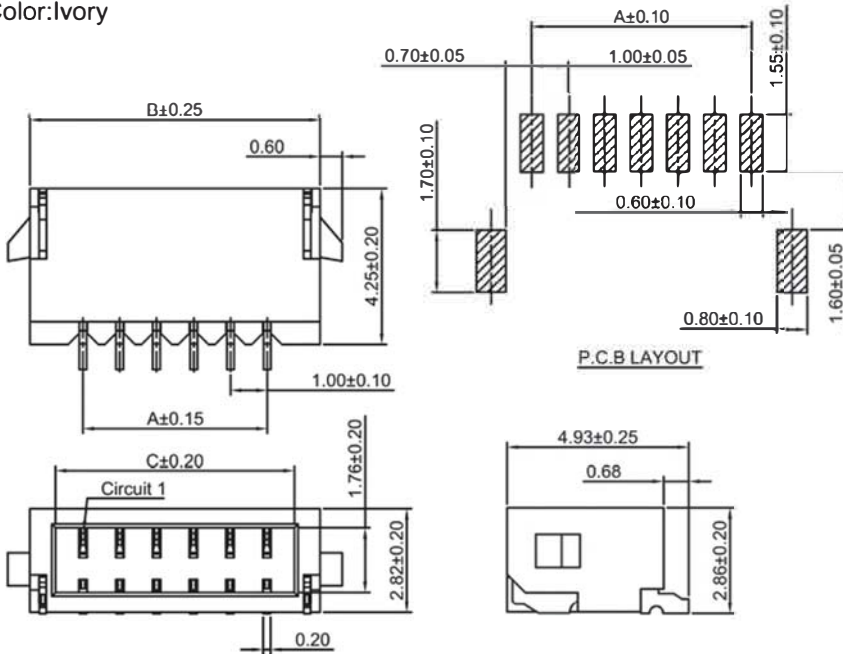
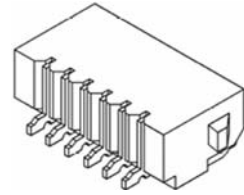

### Ordering Information & Dimensions:

PART NO.	Dimensions		
	A	B	C
A1002WRC-S-02P	1.00	3.90	2.50
A1002WRC-S-03P	2.00	4.90	3.50
A1002WRC-S-04P	3.00	5.90	4.50
A1002WRC-S-05P	4.00	6.90	5.50
A1002WRC-S-06P	5.00	7.90	6.50
A1002WRC-S-07P	6.00	8.90	7.50
A1002WRC-S-08P	7.00	9.90	8.50
A1002WRC-S-09P	8.00	10.90	9.50
A1002WRC-S-10P	9.00	11.90	10.50
A1002WRC-S-11P	10.00	12.90	11.50
A1002WRC-S-12P	11.00	13.90	12.50
A1002WRC-S-13P	12.00	14.90	13.50
A1002WRC-S-14P	13.00	15.90	14.50
A1002WRC-S-15P	14.00	16.90	15.50
A1002WRC-S-16P	15.00	17.90	16.50
A1002WRC-S-17P	16.00	18.90	17.50
A1002WRC-S-18P	17.00	19.90	18.50
A1002WRC-S-19P	18.00	20.90	19.50
A1002WRC-S-20P	19.00	21.90	20.50

Unit:mm

## A1002WRD-S

1.00mm pitch 90° Single Row Wafer - SMT TYPE

### Reference Informations:

- \*Material: Pin: Brass/Tin over Nickel  
Solder Tabs: Brass/Tin over Nickel  
Insulator: Nylon 9T, UL94V-0
- \*Mates with JSV A1002HG , A1002HI series Housing
- \*Color: Ivory

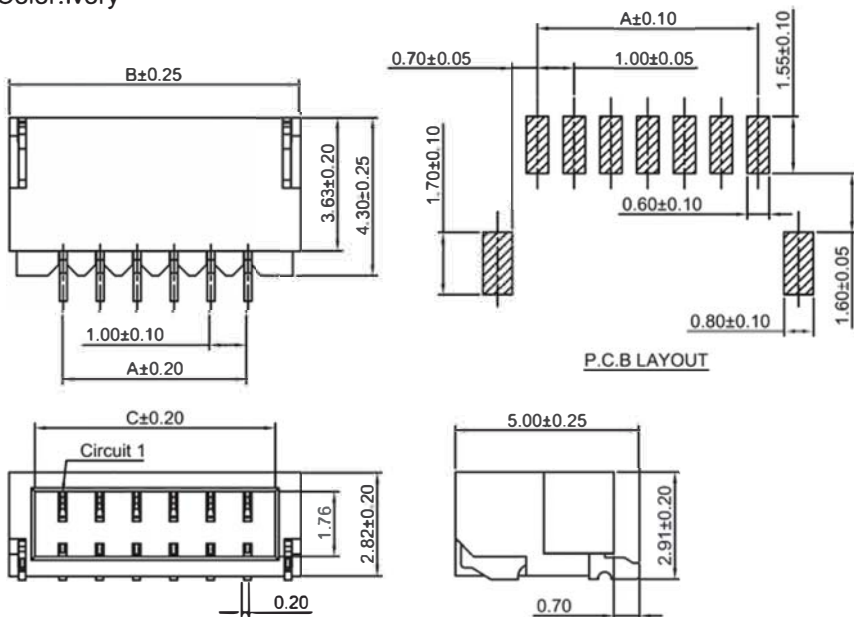

### Ordering Information & Dimensions:

PART NO.	Dimensions		
	A	B	C
A1002WRD-S-02P	1.00	3.90	2.50
A1002WRD-S-03P	2.00	4.90	3.50
A1002WRD-S-04P	3.00	5.90	4.50
A1002WRD-S-05P	4.00	6.90	5.50
A1002WRD-S-06P	5.00	7.90	6.50
A1002WRD-S-07P	6.00	8.90	7.50
A1002WRD-S-08P	7.00	9.90	8.50
A1002WRD-S-09P	8.00	10.90	9.50
A1002WRD-S-10P	9.00	11.90	10.50
A1002WRD-S-11P	10.00	12.90	11.50
A1002WRD-S-12P	11.00	13.90	12.50
A1002WRD-S-13P	12.00	14.90	13.50
A1002WRD-S-14P	13.00	15.90	14.50
A1002WRD-S-15P	14.00	16.90	15.50
A1002WRD-S-16P	15.00	17.90	16.50
A1002WRD-S-17P	16.00	18.90	17.50
A1002WRD-S-18P	17.00	19.90	18.50
A1002WRD-S-19P	18.00	20.90	19.50
A1002WRD-S-20P	19.00	21.90	20.50



# A1002 SERIES

1.00mm pitch wire to board connector

## A1002H-2

1.00mm pitch Dual Row Housing

### Reference Informations:

- \*Material:PBT,UL94V-0
- \*Suitable JSV A1002H-T series Terminal
- \*Mates with JSV A1002WV-S-2 , A1002WV-S-F-2 , A1002WR-S-2 series Wafer
- \*Color:White

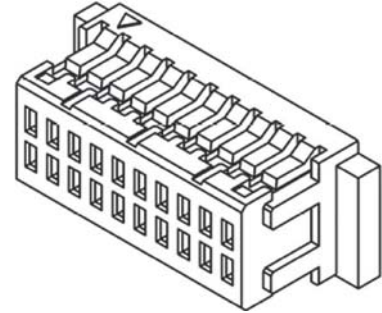
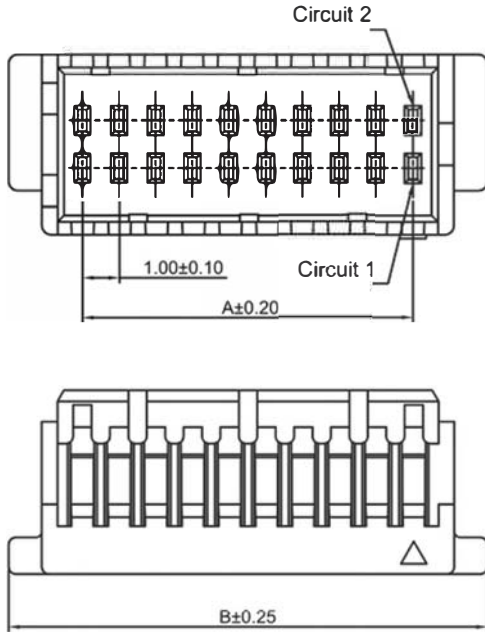

### Ordering Information & Dimensions:

PART NO.	Dimensions	
	A	B
A1002H-2X06P	5.00	9.00
A1002H-2X08P	7.00	11.00
A1002H-2X10P	9.00	13.00
A1002H-2X15P	14.00	18.00
A1002H-2X20P	19.00	23.00
A1002H-2X25P	24.00	28.00

Unit: mm

## A1002WV-S-2

1.00mm pitch 180° Dual Row Wafer - SMT TYPE

### Reference Informations:

- \*Material:Pin:Phosphor Bronze/Tin over Nickel  
Solder Tabs: Phosphor Bronze/Tin over Nickel  
Insulator:Nylon 6T,UL94V-0
- \*Mates with JSV A1002H-2 series Housing
- \*Color:Ivory

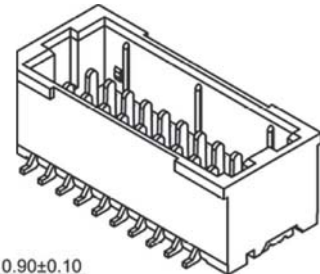
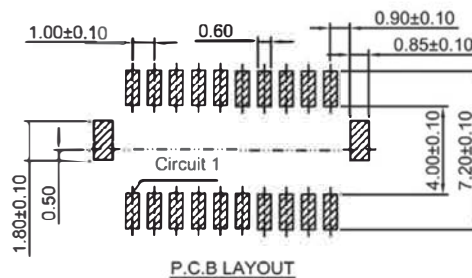
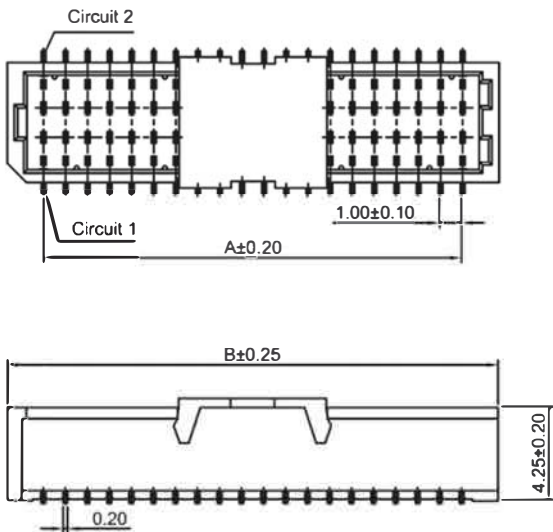

### Ordering Information & Dimensions:

PART NO.	Dimensions	
	A	B
A1002WV-S-2X06P	5.00	8.30
A1002WV-S-2X08P	7.00	10.30
A1002WV-S-2X10P	9.00	12.30
A1002WV-S-2X15P	14.00	17.30
A1002WV-S-2X20P	19.00	22.30
A1002WV-S-2X25P	24.00	27.30

Unit: mm

# A1002 SERIES

1.00mm pitch wire to board connector

## A1002WV-S-F-2

1.00mm pitch 180° Dual Row Wafer - SMT TYPE

### Reference Informations:

- \*Material:Pin:Phosphor Bronze/Tin over Nickel  
Solder Tabs: Phosphor Bronze/Tin over Nickel  
Insulator:Nylon 6T,UL94V-0
- \*Mates with JSV A1002H-2 series Housing
- \*Color:Ivory

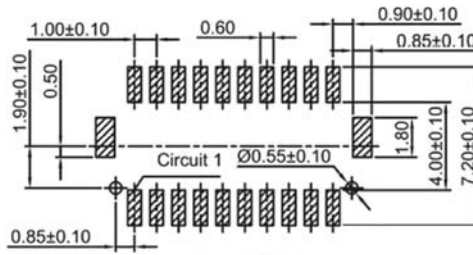
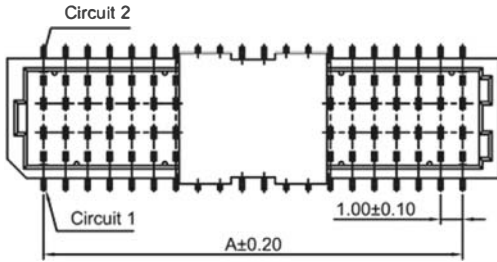
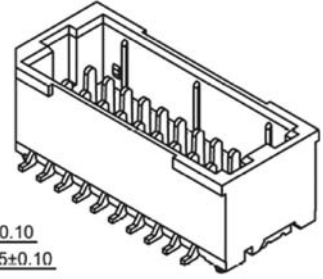

P.C.B LAYOUT

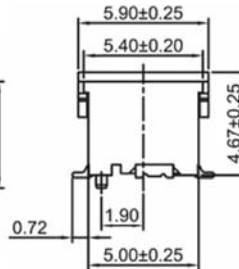
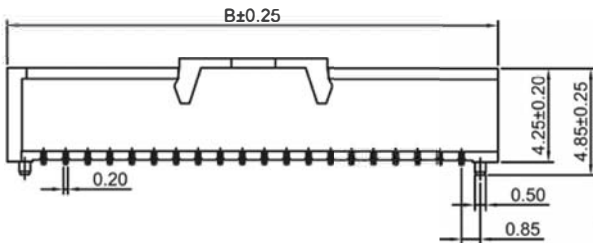

Ordering Information & Dimensions:

PART NO.	Dimensions	
	A	B
A1002WV-S-F-2X06P	5.00	8.30
A1002WV-S-F-2X08P	7.00	10.30
A1002WV-S-F-2X10P	9.00	12.30
A1002WV-S-F-2X15P	14.00	17.30
A1002WV-S-F-2X20P	19.00	22.30
A1002WV-S-F-2X25P	24.00	27.30

Unit: mm

## A1002WR-S-2

1.00mm pitch 90° Dual Row Wafer - SMT TYPE

### Reference Informations:

- \*Material:Pin:Phosphor Bronze/Tin over Nickel  
Solder Tabs: Phosphor Bronze/Tin over Nickel  
Insulator:Nylon 6T,UL94V-0
- \*Mates with JSV A1002H-2 series Housing
- \*Color:Ivory

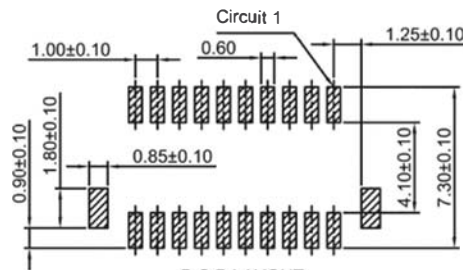
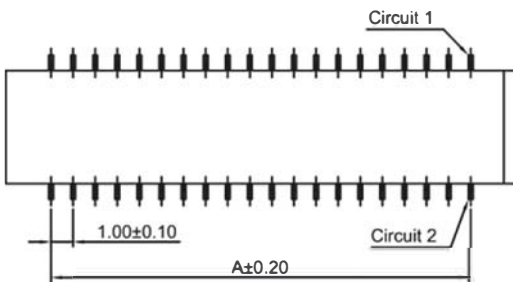
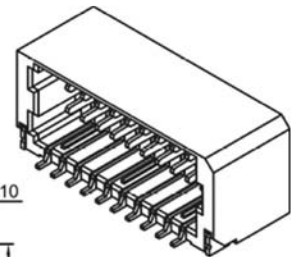

P.C.B LAYOUT

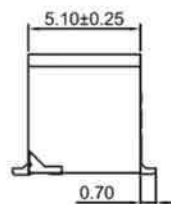
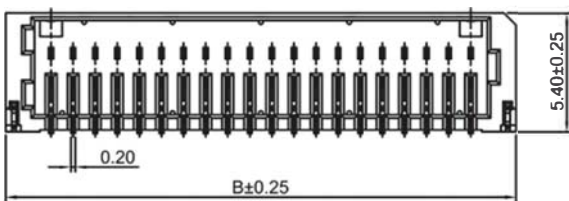

Ordering Information & Dimensions:

PART NO.	Dimensions	
	A	B
A1002WR-S-2X06P	5.00	8.30
A1002WR-S-2X08P	7.00	10.30
A1002WR-S-2X10P	9.00	12.30
A1002WR-S-2X15P	14.00	17.30
A1002WR-S-2X20P	19.00	22.30
A1002WR-S-2X25P	24.00	27.30

Unit: mm



# A1002 SERIES

1.00mm pitch wire to board connector

## A1002WRA-S

1.00mm pitch 90° Single Row Wafer - SMT TYPE

### Reference Informations:

- \*Material: Pin: Brass/Tin over Nickel  
Solder Tabs: Brass/Tin over Nickel  
Insulator: Nylon 6T, UL94V-0
- \*Mates with JSV A1002HA series Housing
- \*Color: Ivory

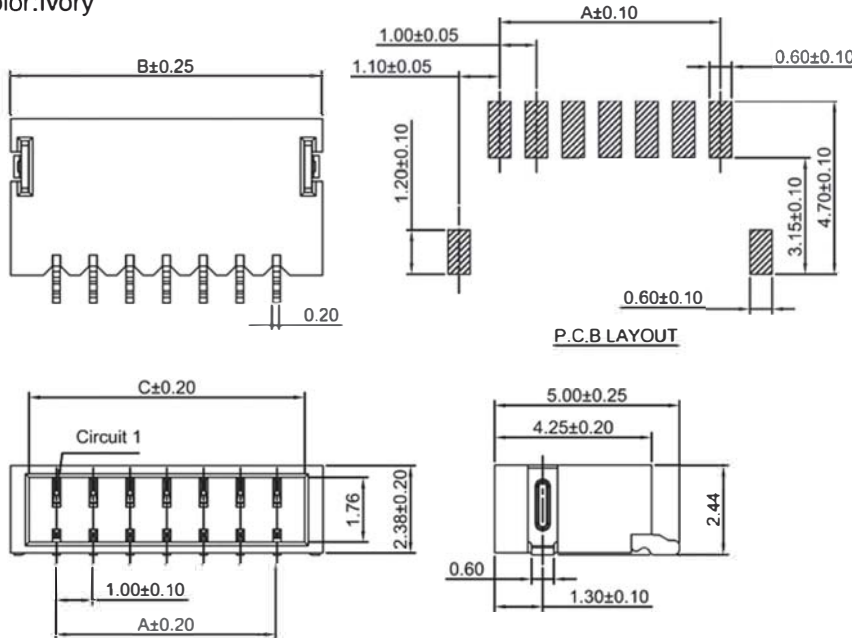

### Ordering Information & Dimensions:

PART NO.	Dimensions		
	A	B	C
A1002WRA-S-02P	1.00	3.50	2.50
A1002WRA-S-03P	2.00	4.50	3.50
A1002WRA-S-04P	3.00	5.50	4.50
A1002WRA-S-05P	4.00	6.50	5.50
A1002WRA-S-06P	5.00	7.50	6.50
A1002WRA-S-07P	6.00	8.50	7.50
A1002WRA-S-08P	7.00	9.50	8.50
A1002WRA-S-09P	8.00	10.50	9.50
A1002WRA-S-10P	9.00	11.50	10.50
A1002WRA-S-11P	10.00	12.50	11.50
A1002WRA-S-12P	11.00	13.50	12.50
A1002WRA-S-13P	12.00	14.50	13.50
A1002WRA-S-14P	13.00	15.50	14.50
A1002WRA-S-15P	14.00	16.50	15.50
A1002WRA-S-16P	15.00	17.50	16.50
A1002WRA-S-17P	16.00	18.50	17.50
A1002WRA-S-18P	17.00	19.50	18.50
A1002WRA-S-19P	18.00	20.50	19.50
A1002WRA-S-20P	19.00	21.50	20.50

Unit:mm