

A1201 SERIES

1.20mm pitch wire to board connector

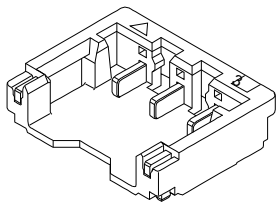
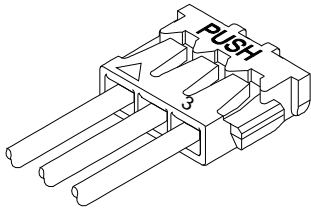

Specifications

Current rating:2A AC,DC
Voltage rating:50V AC,DC
Temperature range:-40°C~+105°C
Contact resistance:10mΩMax.
Insulation resistance:100MΩMin.
Withstanding voltage:500V AC/minute
Compliant with RoHS and REACH
Meet the HF/Halogen Free,need to customize
Contact for details

Standards



Assembly layout

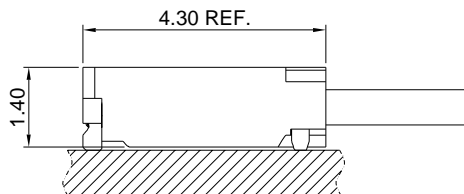

A1201 SERIES

1.20mm pitch wire to board connector

A1201-T

1.20mm pitch Crimp Terminal

Reference Informations:

*Used in A1201 series Housing

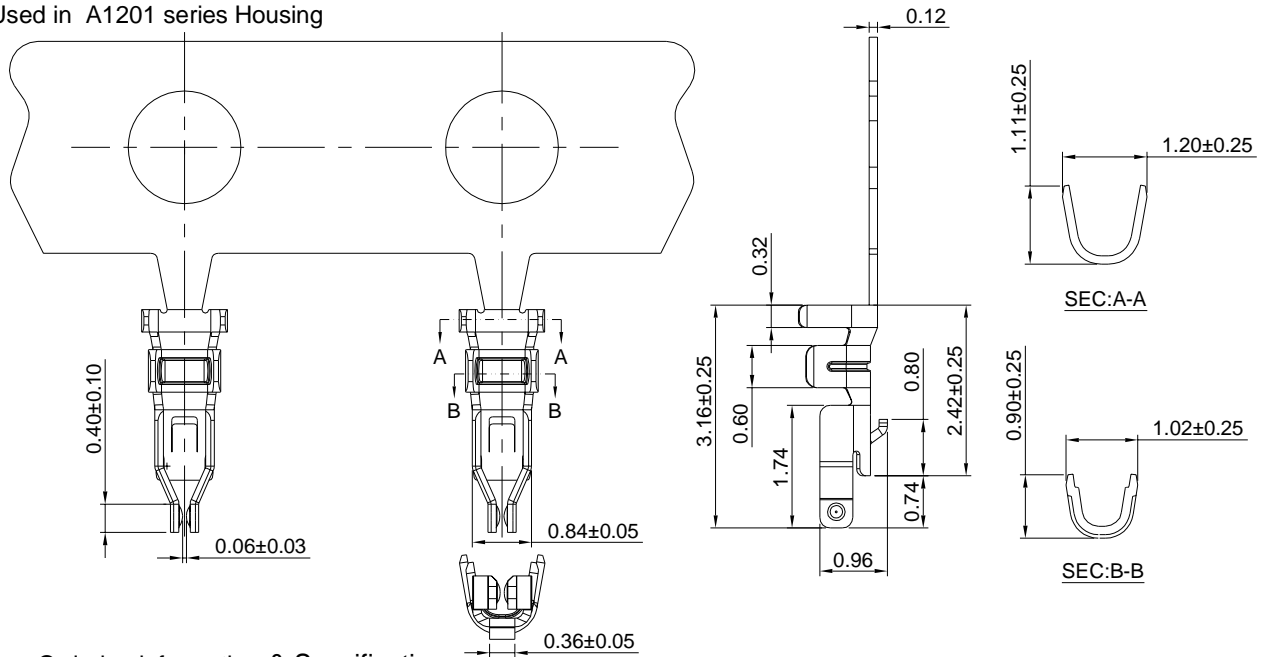

Ordering information & Specifications:

Unit:mm

Part NO.	Wire Range	Insulation O.D.	Material	Finish	Qty/reel
A1201-GP	AWG#28-#30	0.63mm(max)	Phosphor Bronze	Gold over Nickel	30,000 PCS

A1201-T-A

1.20mm pitch Crimp Terminal

Reference Informations:

*Used in A1201HA series Housing

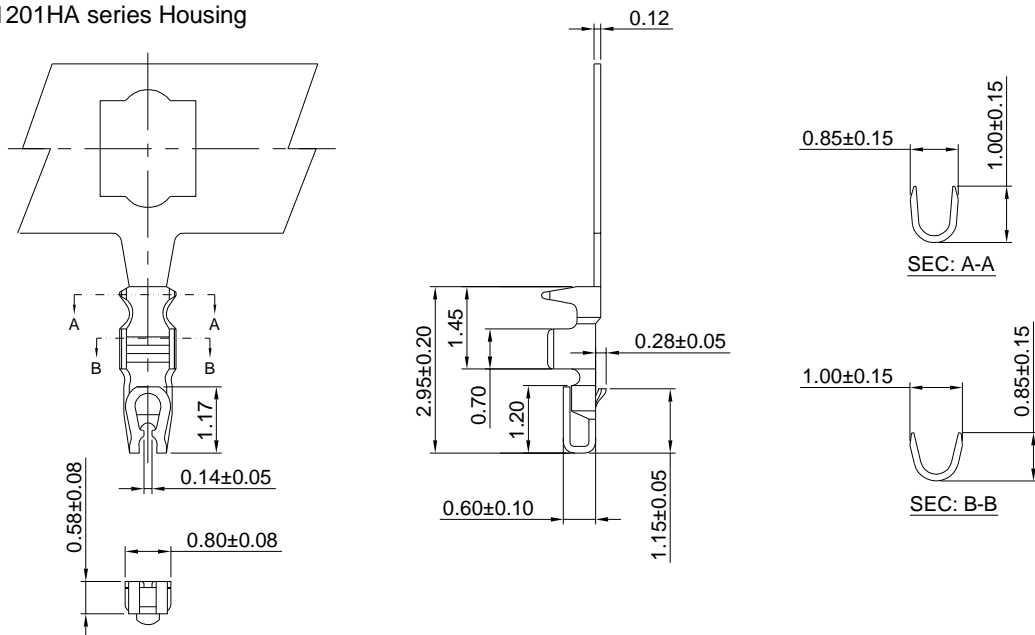

Ordering information & Specifications:

Unit:mm

Part NO.	Wire Range	Insulation O.D.	Material	Finish	Qty/reel
A1201-GP-A	AWG#28-#32	0.63mm(max)	Phosphor Bronze	Gold over Nickel	15,000 PCS

A1201 SERIES

1.20mm pitch wire to board connector

A1201-T-B

1.20mm pitch Crimp Terminal

Reference Informations:

*Used in A1201 series Housing

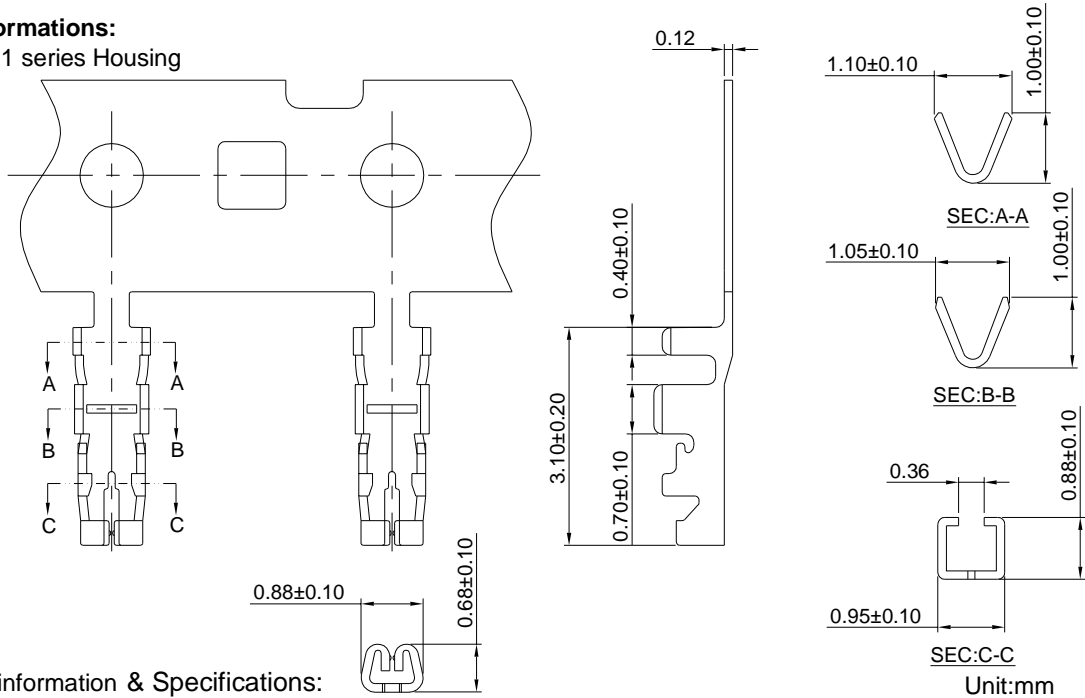

Ordering information & Specifications:

Part NO.	Wire Range	Insulation O.D.	Material	Finish	Qty/reel
A1201-TP-B	AWG#28-#32	0.63mm(max)	Phosphor Bronze	Tin over Nickel	30,000 PCS
A1201-GP-B	AWG#28-#32	0.63mm(max)	Phosphor Bronze	Gold over Nickel	30,000 PCS

A1201H

1.20mm pitch Housing

Reference Informations:

*Material: Nylon 66, UL94V-0

*Suitable A1201-T series Terminal

*Mates with A1201 series Wafer

*Color: Black

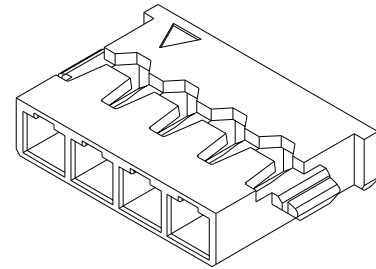
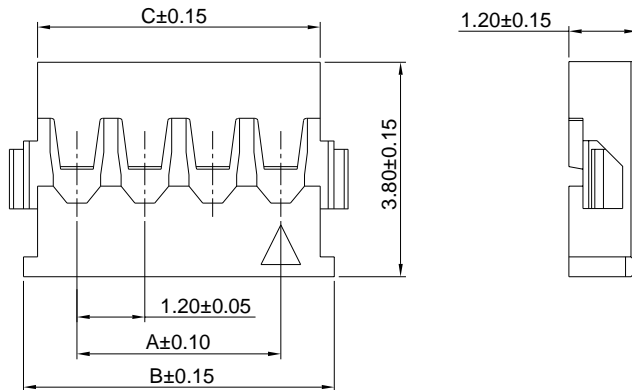
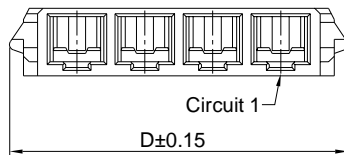

Ordering Information & Dimensions:

PART NO.	Dimensions			
	A	B	C	D
A1201H-2P	1.20	3.10	2.60	3.60
A1201H-3P	2.40	4.30	3.80	4.80
A1201H-4P	3.60	5.50	5.00	6.00
A1201H-5P	4.80	6.70	6.20	7.20
A1201H-6P	6.00	7.90	7.40	8.40
A1201H-7P	7.20	9.10	8.60	9.60
A1201H-8P	8.40	10.30	9.80	10.80
A1201H-9P	9.60	11.50	11.00	12.00
A1201H-10P	10.80	12.70	12.20	13.20
A1201H-11P	12.00	13.90	13.40	14.40
A1201H-12P	13.20	15.10	14.60	15.60
A1201H-13P	14.40	16.30	15.80	16.80
A1201H-14P	15.60	17.50	17.00	18.00
A1201H-15P	16.80	18.70	18.20	19.20

Unit: mm

A1201 SERIES

1.20mm pitch wire to board connector

A1201HA

1.20mm pitch Housing

Reference Informations:

- *Material:LCP,UL94V-0
- *Suitable A1201-T-A series Terminal
- *Mates with A1201WRA series Wafer
- *Color:White

Ordering Information:

A1201HA-XP - **
 1 2
 1.Part No.
 2.Color:
 (blank):White
 BK:Black

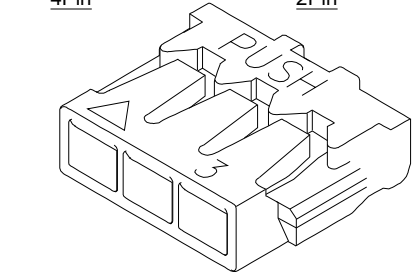
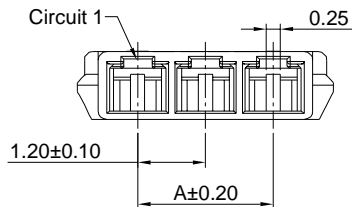
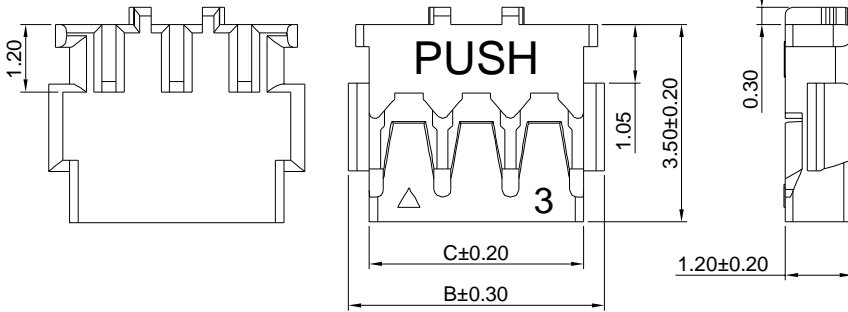
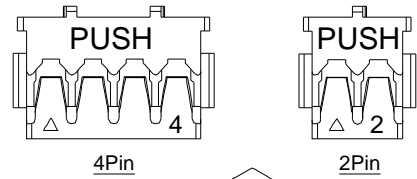

Ordering Information & Dimensions:

PART NO.	Dimensions		
	A	B	C
A1201HA-2P	1.20	3.35	2.60
A1201HA-3P	2.40	4.55	3.80
A1201HA-4P	3.60	5.75	5.00
A1201HA-5P	4.80	6.95	6.20
A1201HA-6P	6.00	8.15	7.40
A1201HA-7P	7.20	9.35	8.60
A1201HA-8P	8.40	10.55	9.80
A1201HA-9P	9.60	11.75	11.00
A1201HA-10P	10.80	12.95	12.20

Unit: mm

A1201HB

1.20mm pitch Housing

Reference Informations:

- *Material:PBT,UL94V-0
- *Suitable A1201-B series Terminal
- *Color:Natural

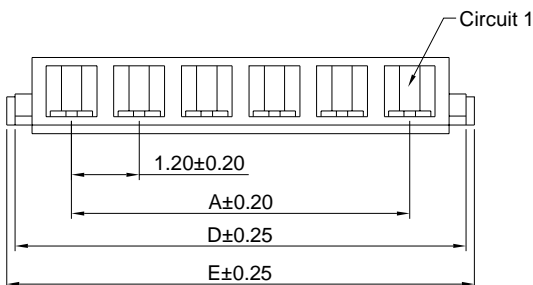
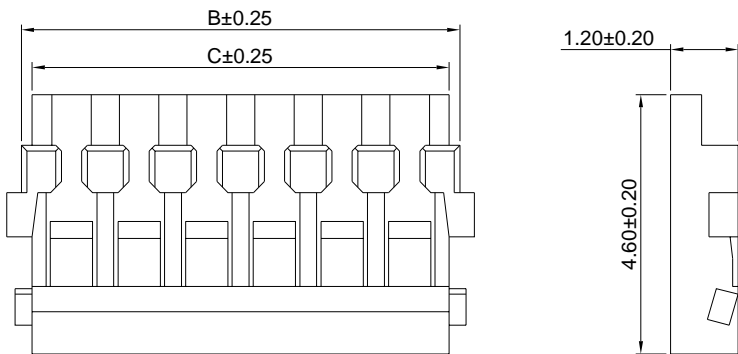

Ordering Information & Dimensions:

PART NO.	Dimensions				
	A	B	C	D	E
A1201HB-2P	1.20	2.98	2.60	3.20	3.50
A1201HB-3P	2.40	4.18	3.80	4.40	4.70
A1201HB-4P	3.60	5.38	5.00	5.60	5.90
A1201HB-5P	4.80	6.58	6.20	6.80	7.10
A1201HB-6P	6.00	7.78	7.40	8.00	8.30

Unit: mm

A1201 SERIES

1.20mm pitch wire to board connector

A1201HC

1.20mm pitch Housing

Reference Informations:

- *Material: PBT, UL94V-0
- *Suitable A1201-B series Terminal
- *Color: Natural

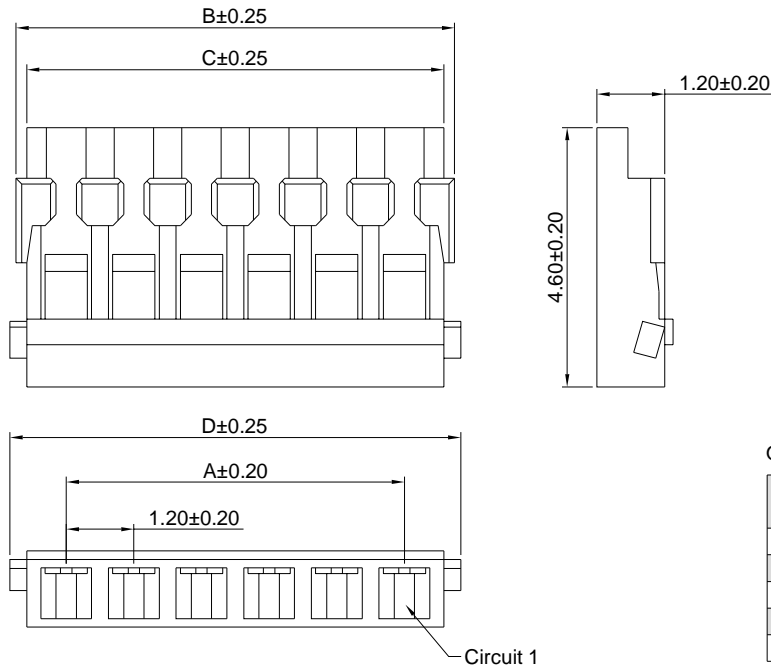

Ordering Information & Dimensions:

PART NO.	Dimensions			
	A	B	C	D
A1201HC-2P	1.20	2.98	2.60	3.20
A1201HC-3P	2.40	4.18	3.80	4.40
A1201HC-4P	3.60	5.38	5.00	5.60
A1201HC-5P	4.80	6.58	6.20	6.80
A1201HC-6P	6.00	7.78	7.40	8.00

Unit: mm

A1201WR-S

1.20mm pitch 90° Wafer - SMT TYPE

Reference Informations:

- *Material: Pin: Phosphor Bronze/Gold over Nickel
- Insulator: Nylon 6T, UL94V-0
- Solder Tab: Phosphor Bronze/Tin over Nickel
- *Mates with A1201 series Housing
- *Color: Black

Ordering Information:

A1201WR-S-XP - **

1. Part No.
2. Color:
(blank): Black
IV: Ivory

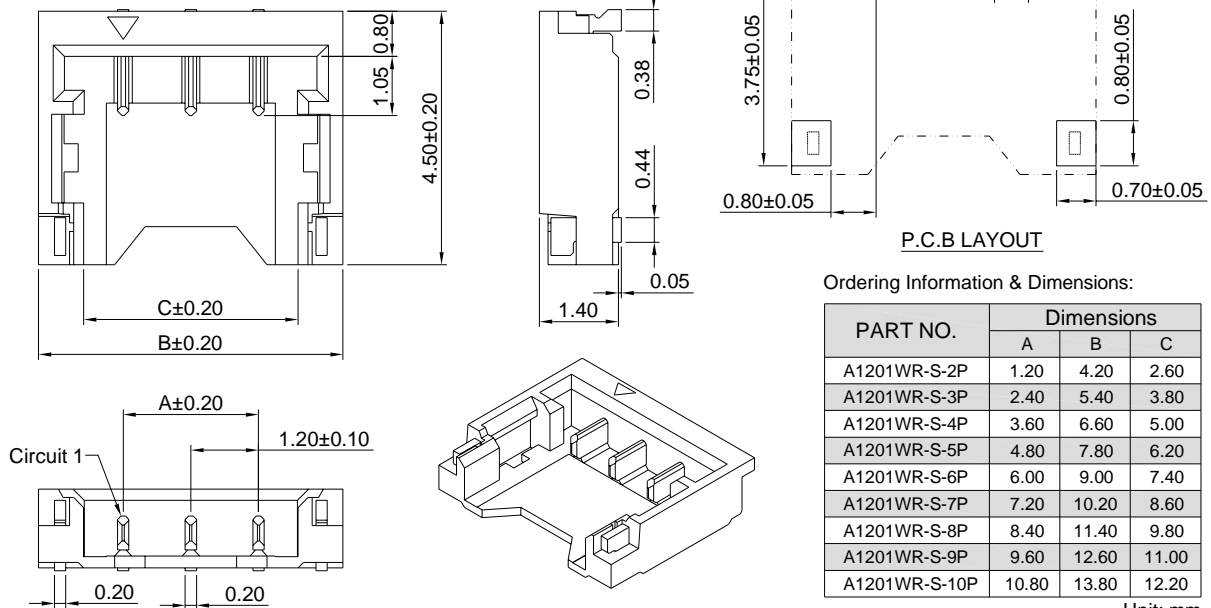

Ordering Information & Dimensions:

PART NO.	Dimensions		
	A	B	C
A1201WR-S-2P	1.20	4.20	2.60
A1201WR-S-3P	2.40	5.40	3.80
A1201WR-S-4P	3.60	6.60	5.00
A1201WR-S-5P	4.80	7.80	6.20
A1201WR-S-6P	6.00	9.00	7.40
A1201WR-S-7P	7.20	10.20	8.60
A1201WR-S-8P	8.40	11.40	9.80
A1201WR-S-9P	9.60	12.60	11.00
A1201WR-S-10P	10.80	13.80	12.20

Unit: mm

A1201 SERIES

1.20mm pitch wire to board connector

A1201WRA-S

1.20mm pitch 90° Wafer - SMT TYPE

Reference Informations:

- *Material:Pin:Phosphor Bronze/Gold over Nickel
- Insulator:Nylon 6T,UL94V-0
- Solder Tab: Phosphor Bronze/Tin over Nickel
- *Mates with A1201HA series Housing
- *Color:Ivory

Ordering Information:
A1201WRA-S-XP - **

- 1 2
- 1.Part No.
 - 2.Material:
(blank):Ivory
BK:Black

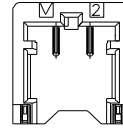

2Pin

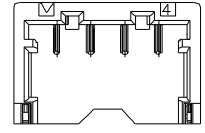

4Pin

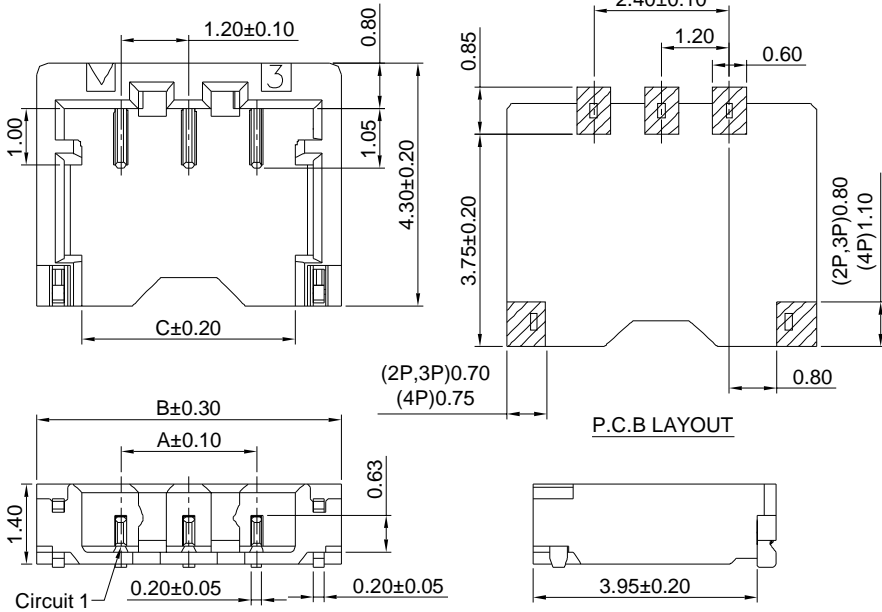
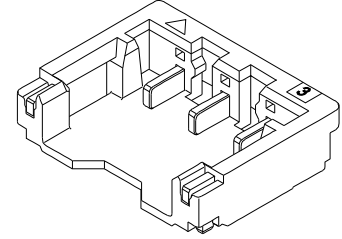

Ordering Information & Dimensions:

PART NO.	Dimensions		
	A	B	C
A1201WRA-S-2P	1.20	4.20	2.60
A1201WRA-S-3P	2.40	5.40	3.80
A1201WRA-S-4P	3.60	6.60	5.00
A1201WRA-S-5P	4.80	7.80	6.20
A1201WRA-S-6P	6.00	9.00	7.40
A1201WRA-S-7P	7.20	10.20	8.60
A1201WRA-S-8P	8.40	11.40	9.80
A1201WRA-S-9P	9.60	12.60	11.00
A1201WRA-S-10P	10.80	13.80	12.20

Unit: mm