

A1252 SERIES

1.25mm pitch wire to board connector

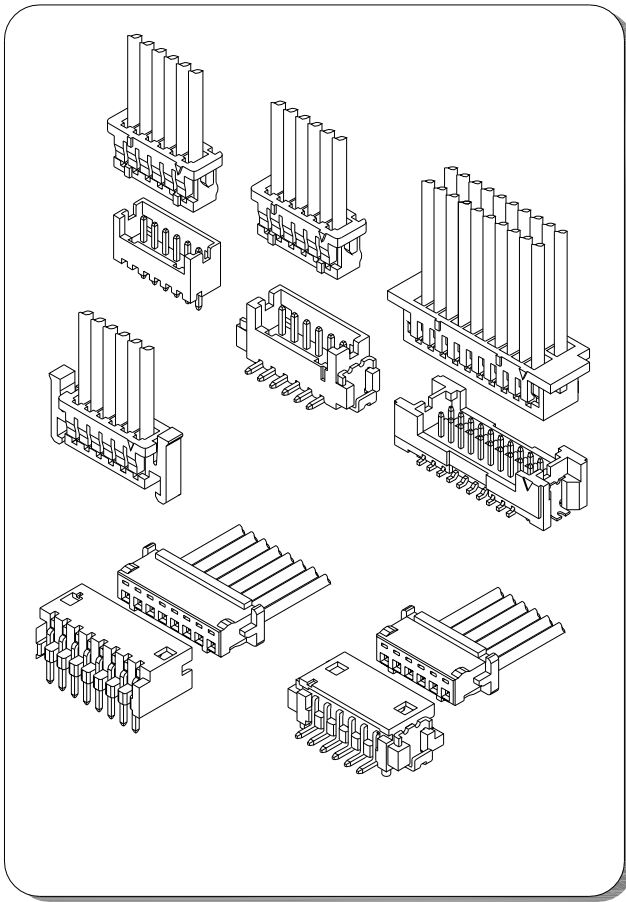

Specifications

- Current rating: 1A AC, DC
- Voltage rating: 150V AC, DC
- Temperature range: -40°C ~ +105°C
- Contact resistance: 30mΩ Max.
- Insulation resistance: 500MΩ Min.
- Withstanding voltage: 500V AC/minute
- *Compliant with RoHS and REACH*
- *Meet the HF/Halogen Free, need to customize*
- *Contact for details*

Standards



Assembly layout

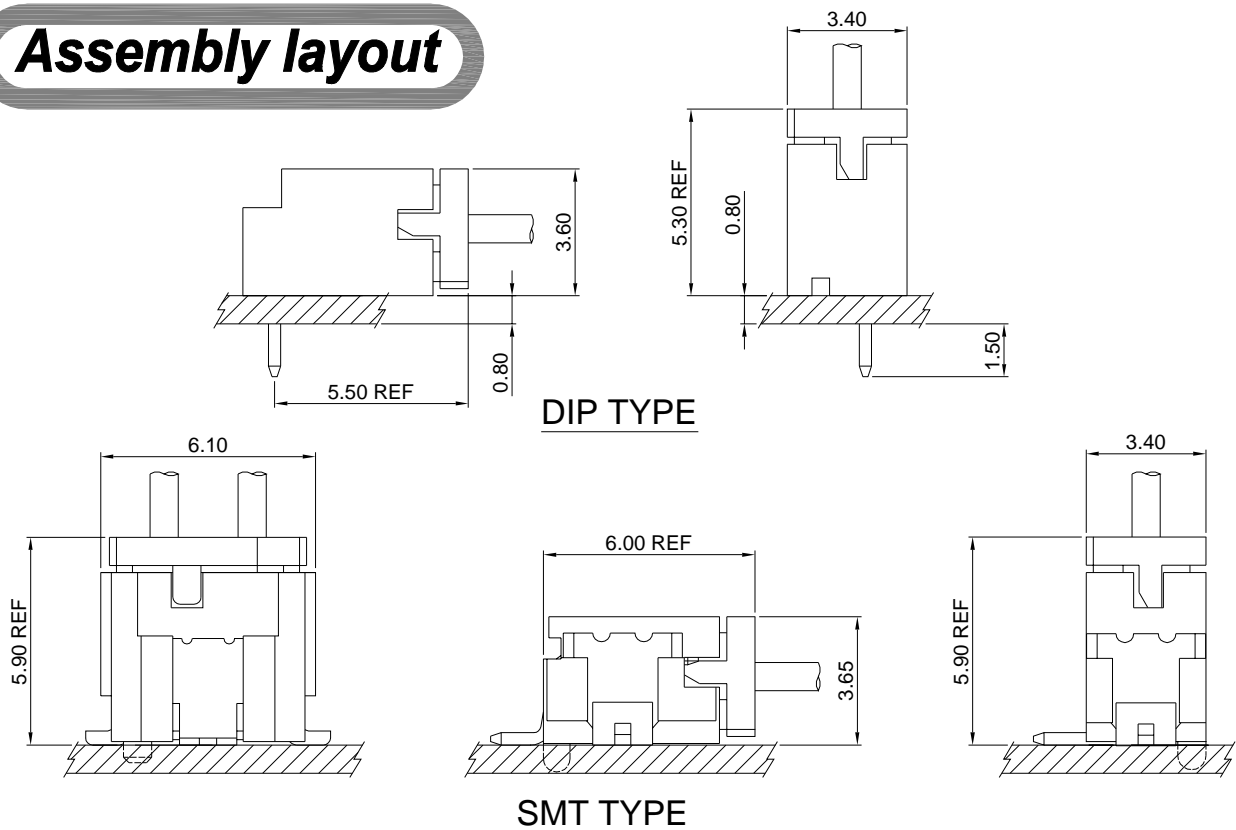

A1252 SERIES

1.25mm pitch wire to board connector

A1252-T

1.25mm pitch Crimp Terminal

Reference Informations:

*Used in A1252 series Housing

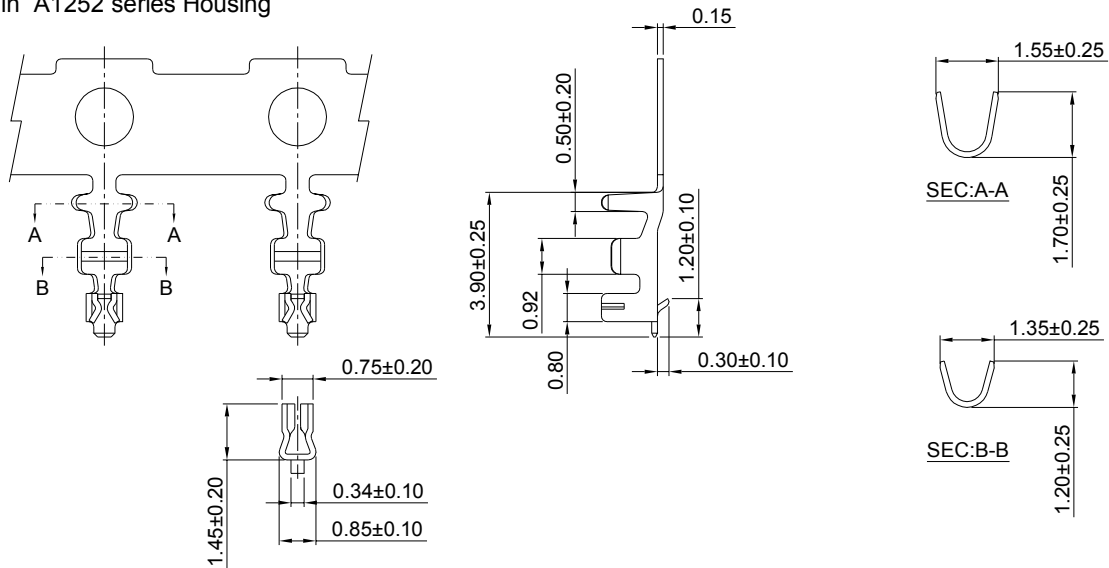

Ordering information & Specifications:

Unit:mm

Part NO.	Wire Range	Insulation O.D.	Material	Finish	Qty/reel
A1252-TP	AWG#26-#30	1.00mm(max)	Phosphor Bronze	Tin over Nickel	10,000 PCS
A1252-GP	AWG#26-#30	1.00mm(max)	Phosphor Bronze	Gold over Nickel	10,000 PCS

Optional Gold plating available but MOQ requested

A1252H

1.25mm pitch Single Row Housing

Reference Informations:

*Material:Nylon 66,UL94V-0

*Suitable A1252 series Terminal

*Mates with A1252 series Single Row Wafer

*Color:Gray

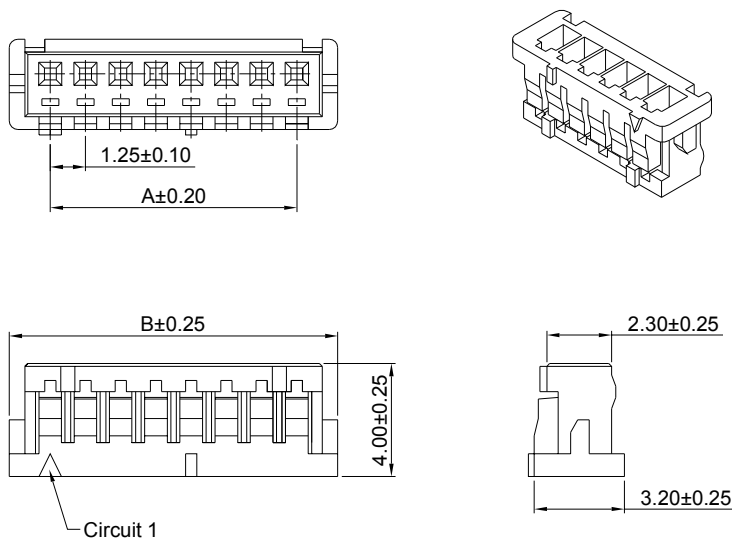

Ordering Information & Dimensions:

PART NO.	Dimensions	
	A	B
A1252H-2P	1.25	4.15
A1252H-3P	2.50	5.40
A1252H-4P	3.75	6.65
A1252H-5P	5.00	7.90
A1252H-6P	6.25	9.15
A1252H-7P	7.50	10.40
A1252H-8P	8.75	11.65
A1252H-9P	10.00	12.90
A1252H-10P	11.25	14.15
A1252H-11P	12.50	15.40
A1252H-12P	13.75	16.65
A1252H-13P	15.00	17.90
A1252H-14P	16.25	19.15
A1252H-15P	17.50	20.40

Unit: mm

A1252 SERIES

1.25mm pitch wire to board connector

A1252HA

1.25mm pitch Single Row Housing

Reference Informations:

- *Material:Nylon 66,UL94V-0
- *Suitable A1252 series Terminal
- *Color:White

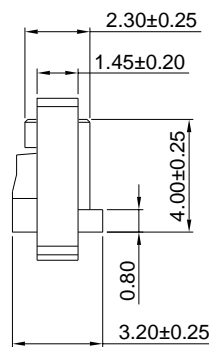
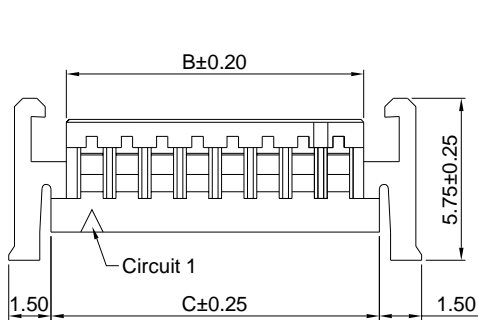
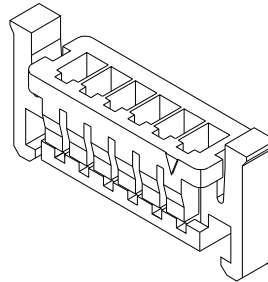
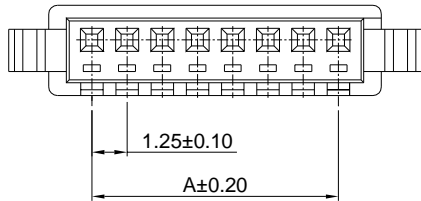

Ordering Information & Dimensions:

PART NO.	Dimensions		
	A	B	C
A1252HA-2P	1.25	2.90	4.15
A1252HA-3P	2.50	4.15	5.40
A1252HA-4P	3.75	5.40	6.65
A1252HA-5P	5.00	6.65	7.90
A1252HA-6P	6.25	7.90	9.15
A1252HA-7P	7.50	9.15	10.40
A1252HA-8P	8.75	10.40	11.65
A1252HA-9P	10.00	11.65	12.90
A1252HA-10P	11.25	12.90	14.15
A1252HA-11P	12.50	14.15	15.40
A1252HA-12P	13.75	15.40	16.65
A1252HA-13P	15.00	16.65	17.90
A1252HA-14P	16.25	17.90	19.15
A1252HA-15P	17.50	19.15	20.40

Unit: mm

A1252H-2

1.25mm pitch Dual Row Housing

Reference Informations:

- *Material:Nylon 66,UL94V-0
- *Suitable A1252 series Terminal
- *Mates with A1252WV-S,A1252WV-S-F series Dual Row Wafer
- *Color:Gray

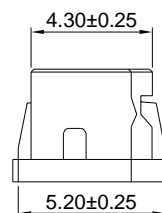
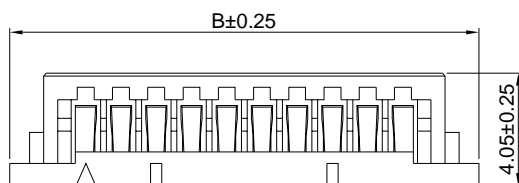
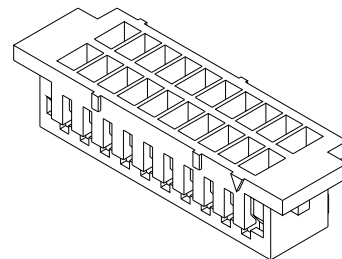
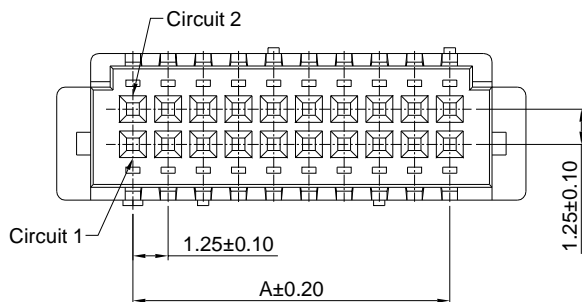

Ordering Information & Dimensions:

PART NO.	Dimensions	
	A	B
A1252H-2x5P	5.00	10.40
A1252H-2x7P	7.50	12.90
A1252H-2x10P	11.25	16.65
A1252H-2x15P	17.50	22.90
A1252H-2x20P	23.75	29.15

Unit: mm

A1252 SERIES

1.25mm pitch wire to board connector

A1252WV

1.25mm pitch 180° Single Row Wafer

Reference Informations:

- *Material:Pin:Brass/Tin over Nickel
Insulator:Nylon 66,UL94V-0
- *Mates with A1252 series Single Row Housing
- *Color:Gray

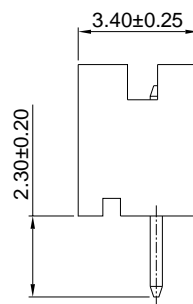
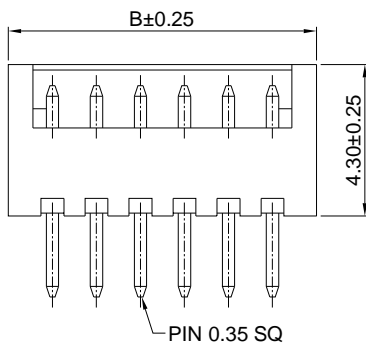
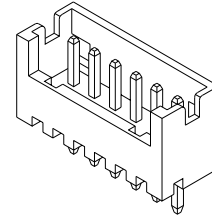
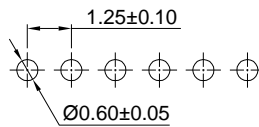
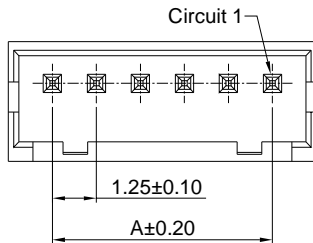

Ordering Information & Dimensions:

PART NO.	Dimensions	
	A	B
A1252WV-2P	1.25	3.75
A1252WV-3P	2.50	5.00
A1252WV-4P	3.75	6.25
A1252WV-5P	5.00	7.50
A1252WV-6P	6.25	8.75
A1252WV-7P	7.50	10.00
A1252WV-8P	8.75	11.25
A1252WV-9P	10.00	12.50
A1252WV-10P	11.25	13.75
A1252WV-11P	12.50	15.00
A1252WV-12P	13.75	16.25
A1252WV-13P	15.00	17.50
A1252WV-14P	16.25	18.75
A1252WV-15P	17.50	20.00

Unit: mm

A1252WV-S

1.25mm pitch 180° Single Row Wafer-SMT TYPE

Reference Informations:

- *Material:Pin:Brass/Tin over Nickel
Insulator:Nylon 6T,UL94V-0
Cap:Nylon 6T,UL94V-0
- *Mates with A1252 series Single Row Housing
- *Color:Ivory

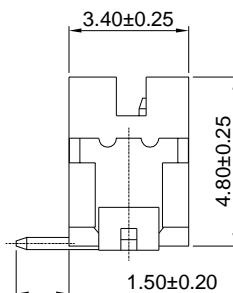
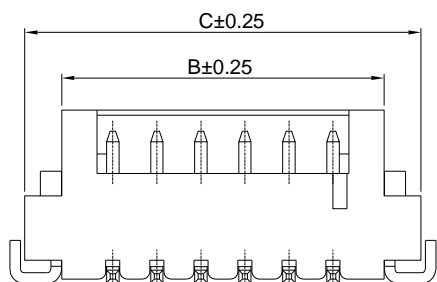
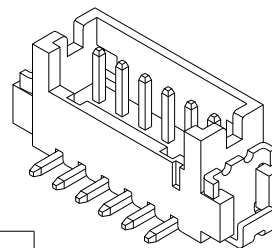
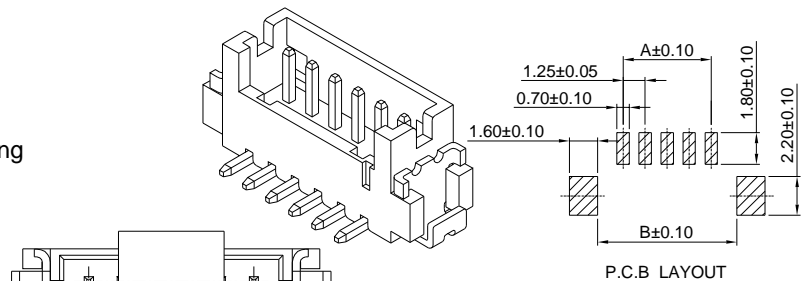
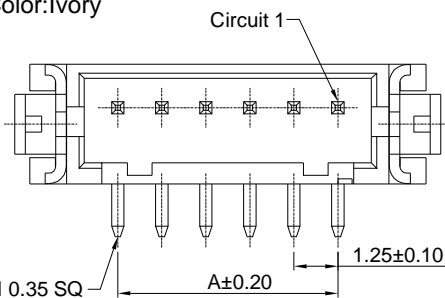

CAP
(FOR PICK AND
PLACE SYSTEMS)

Ordering Information & Dimensions:

PART NO.	Dimensions		
	A	B	C
A1252WV-S-2P	1.25	4.15	6.25
A1252WV-S-3P	2.50	5.40	7.50
A1252WV-S-4P	3.75	6.65	8.75
A1252WV-S-5P	5.00	7.90	10.00
A1252WV-S-6P	6.25	9.15	11.25
A1252WV-S-7P	7.50	10.40	12.50
A1252WV-S-8P	8.75	11.65	13.75
A1252WV-S-9P	10.00	12.90	15.00
A1252WV-S-10P	11.25	14.15	16.25
A1252WV-S-11P	12.50	15.40	17.50
A1252WV-S-12P	13.75	16.65	18.75
A1252WV-S-13P	15.00	17.90	20.00
A1252WV-S-14P	16.25	19.15	21.25
A1252WV-S-15P	17.50	20.40	22.50

Unit: mm

A1252 SERIES

1.25mm pitch wire to board connector

A1252WV-S-F

1.25mm pitch 180° Single Row Wafer-SMT TYPE

Reference Informations:

- *Material: Pin: Brass/Tin over Nickel
Solder Tabs: Phosphor Bronze/Tin over Nickel
Insulator: Nylon 6T, UL94V-0
Cap: Nylon 6T, UL94V-0

- *Mates with A1252 series Single Row Housing
- *Color: Ivory

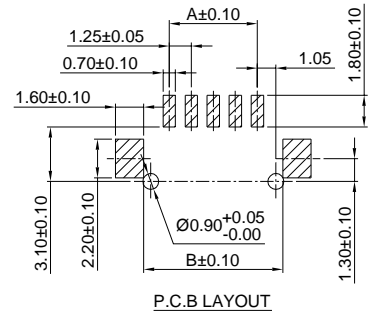
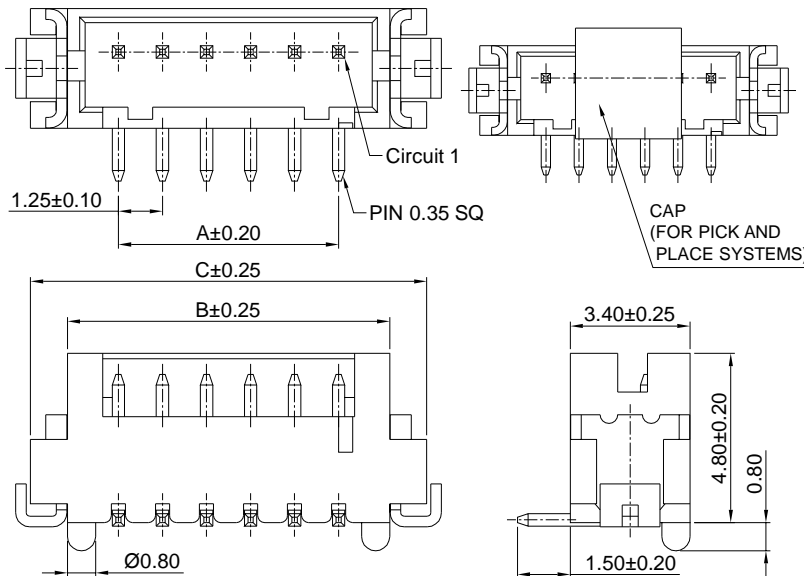

Ordering Information & Dimensions:

PART NO.	Dimensions		
	A	B	C
A1252WV-S-F-2P	1.25	4.15	6.25
A1252WV-S-F-3P	2.50	5.40	7.50
A1252WV-S-F-4P	3.75	6.65	8.75
A1252WV-S-F-5P	5.00	7.90	10.00
A1252WV-S-F-6P	6.25	9.15	11.25
A1252WV-S-F-7P	7.50	10.40	12.50
A1252WV-S-F-8P	8.75	11.65	13.75
A1252WV-S-F-9P	10.00	12.90	15.00
A1252WV-S-F-10P	11.25	14.15	16.25
A1252WV-S-F-11P	12.50	15.40	17.50
A1252WV-S-F-12P	13.75	16.65	18.75
A1252WV-S-F-13P	15.00	17.90	20.00
A1252WV-S-F-14P	16.25	19.15	21.25
A1252WV-S-F-15P	17.50	20.40	22.50

Unit: mm

A1252WR

1.25mm pitch 90° Single Row Wafer

Reference Informations:

- *Material: Pin: Brass/Tin over Nickel
Insulator: Nylon 66, UL94V-0
- *Mates with A1252 series Single Row Housing
- *Color: Gray

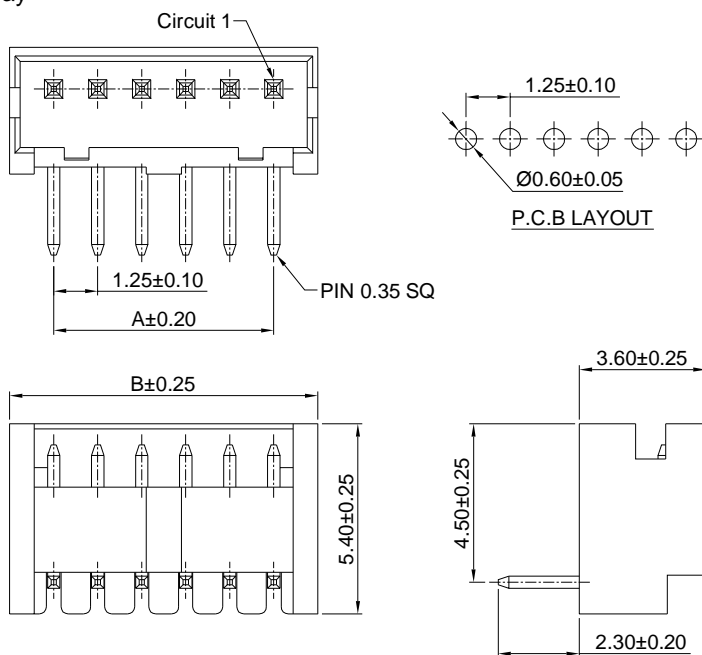

Ordering Information & Dimensions:

PART NO.	Dimensions	
	A	B
A1252WR-2P	1.25	3.75
A1252WR-3P	2.50	5.00
A1252WR-4P	3.75	6.25
A1252WR-5P	5.00	7.50
A1252WR-6P	6.25	8.75
A1252WR-7P	7.50	10.00
A1252WR-8P	8.75	11.25
A1252WR-9P	10.00	12.50
A1252WR-10P	11.25	13.75
A1252WR-11P	12.50	15.00
A1252WR-12P	13.75	16.25
A1252WR-13P	15.00	17.50
A1252WR-14P	16.25	18.75
A1252WR-15P	17.50	20.00

Unit: mm

A1252 SERIES

1.25mm pitch wire to board connector

A1252WR-S

1.25mm pitch 90° Single Row Wafer-SMT TYPE

Reference Informations:

- *Material:Pin:Brass/Tin over Nickel
Solder Tabs:Phosphor Bronze/Tin over Nickel
Insulator:Nylon 6T,UL94V-0
- *Mates with A1252 series Single Row Housing
- *Color:Ivory

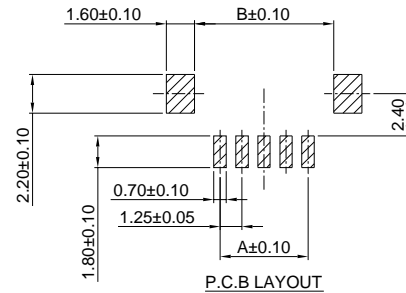
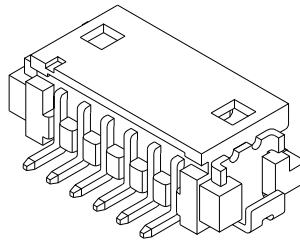
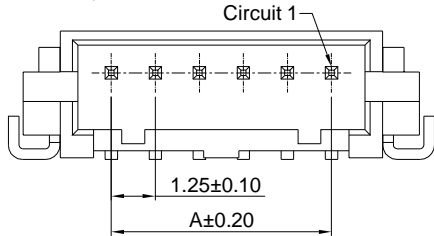

Ordering Information & Dimensions:

PART NO.	Dimensions		
	A	B	C
A1252WR-S-2P	1.25	4.15	6.25
A1252WR-S-3P	2.50	5.40	7.50
A1252WR-S-4P	3.75	6.65	8.75
A1252WR-S-5P	5.00	7.90	10.00
A1252WR-S-6P	6.25	9.15	11.25
A1252WR-S-7P	7.50	10.40	12.50
A1252WR-S-8P	8.75	11.65	13.75
A1252WR-S-9P	10.00	12.90	15.00
A1252WR-S-10P	11.25	14.15	16.25
A1252WR-S-11P	12.50	15.40	17.50
A1252WR-S-12P	13.75	16.65	18.75
A1252WR-S-13P	15.00	17.90	20.00
A1252WR-S-14P	16.25	19.15	21.25
A1252WR-S-15P	17.50	20.40	22.50

Unit: mm

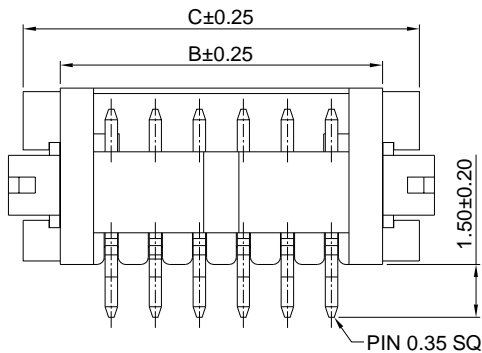

A1252WR-S-F

1.25mm pitch 90° Single Row Wafer-SMT TYPE

Reference Informations:

- *Material:Pin:Brass/Tin over Nickel
Solder Tabs:Phosphor Bronze/Tin over Nickel
Insulator:Nylon 6T,UL94V-0
- *Mates with A1252 series Single Row Housing
- *Color:Ivory

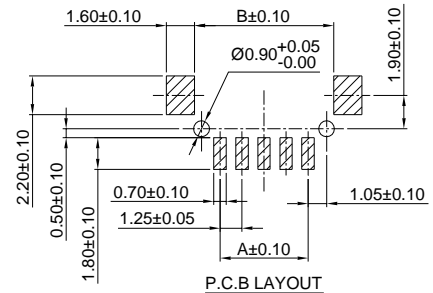
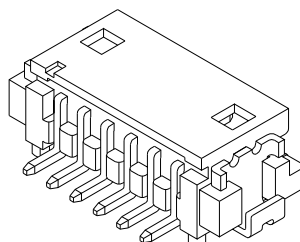
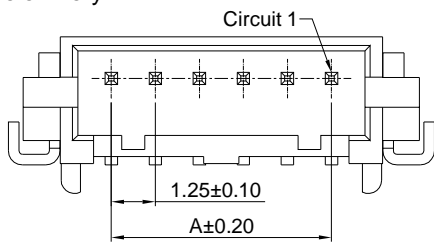

Ordering Information & Dimensions:

PART NO.	Dimensions		
	A	B	C
A1252WR-S-F-2P	1.25	4.15	6.25
A1252WR-S-F-3P	2.50	5.40	7.50
A1252WR-S-F-4P	3.75	6.65	8.75
A1252WR-S-F-5P	5.00	7.90	10.00
A1252WR-S-F-6P	6.25	9.15	11.25
A1252WR-S-F-7P	7.50	10.40	12.50
A1252WR-S-F-8P	8.75	11.65	13.75
A1252WR-S-F-9P	10.00	12.90	15.00
A1252WR-S-F-10P	11.25	14.15	16.25
A1252WR-S-F-11P	12.50	15.40	17.50
A1252WR-S-F-12P	13.75	16.65	18.75
A1252WR-S-F-13P	15.00	17.90	20.00
A1252WR-S-F-14P	16.25	19.15	21.25
A1252WR-S-F-15P	17.50	20.40	22.50

Unit: mm

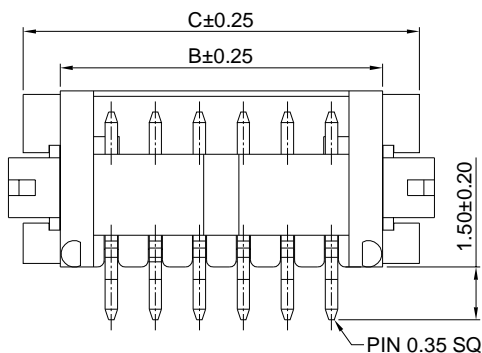

A1252 SERIES

1.25mm pitch wire to board connector

A1252WV-S-2

1.25mm pitch 180° Dual Row Wafer-SMT TYPE

Reference Informations:

- *Material:Pin:Brass/Tin over Nickel
Solder Tabs:Phosphor Bronze/Tin over Nickel
Insulator:Nylon 6T,UL94V-0
Cap:Nylon 6T,UL94V-0

- *Mates with A1252 series Dual Row Housing
- *Color:Ivory

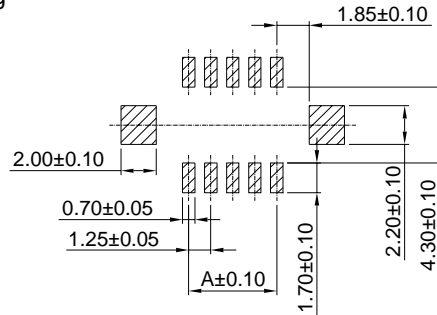
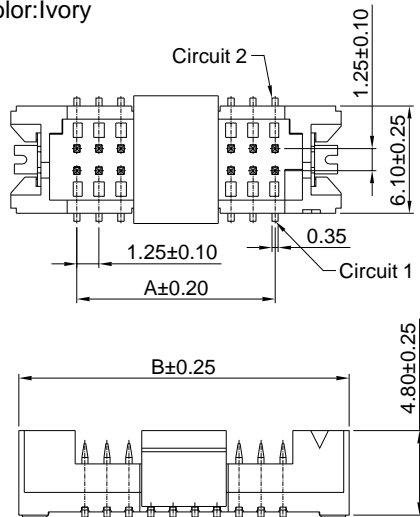
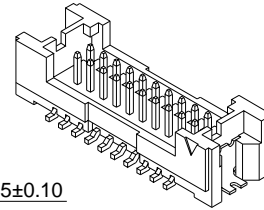

P.C.B LAYOUT

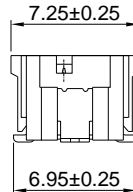

Ordering Information & Dimensions:

PART NO.	Dimensions	
	A	B
A1252WV-S-2x5P	5.00	12.50
A1252WV-S-2x7P	7.50	15.00
A1252WV-S-2x10P	11.25	18.75
A1252WV-S-2x15P	17.50	25.00
A1252WV-S-2x20P	23.75	31.25

Unit: mm

A1252WV-S-F-2

1.25mm pitch 180° Dual Row Wafer-SMT TYPE

Reference Informations:

- *Material:Pin:Brass/Tin over Nickel
Solder Tabs:Phosphor Bronze/Tin over Nickel
Insulator:Nylon 6T,UL94V-0
Cap:Nylon 6T,UL94V-0

- *Mates with A1252 series Dual Row Housing
- *Color:Ivory

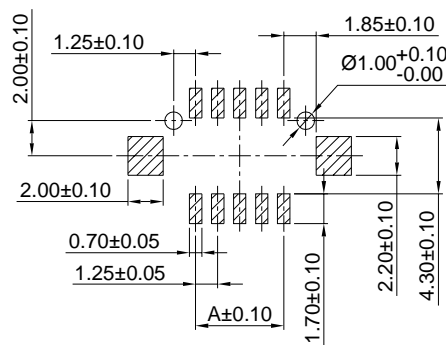
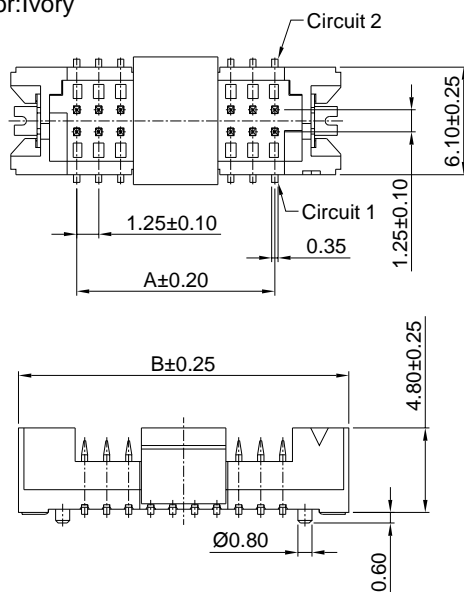
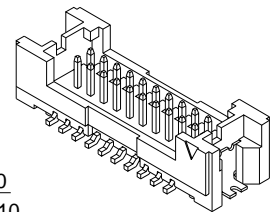

P.C.B LAYOUT

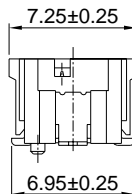

Ordering Information & Dimensions:

PART NO.	Dimensions	
	A	B
A1252WV-S-F-2x5P	5.00	12.50
A1252WV-S-F-2x7P	7.50	15.00
A1252WV-S-F-2x10P	11.25	18.75
A1252WV-S-F-2x15P	17.50	25.00
A1252WV-S-F-2x20P	23.75	31.25

Unit: mm