

A1254 SERIES

1.25mm pitch wire to board connector

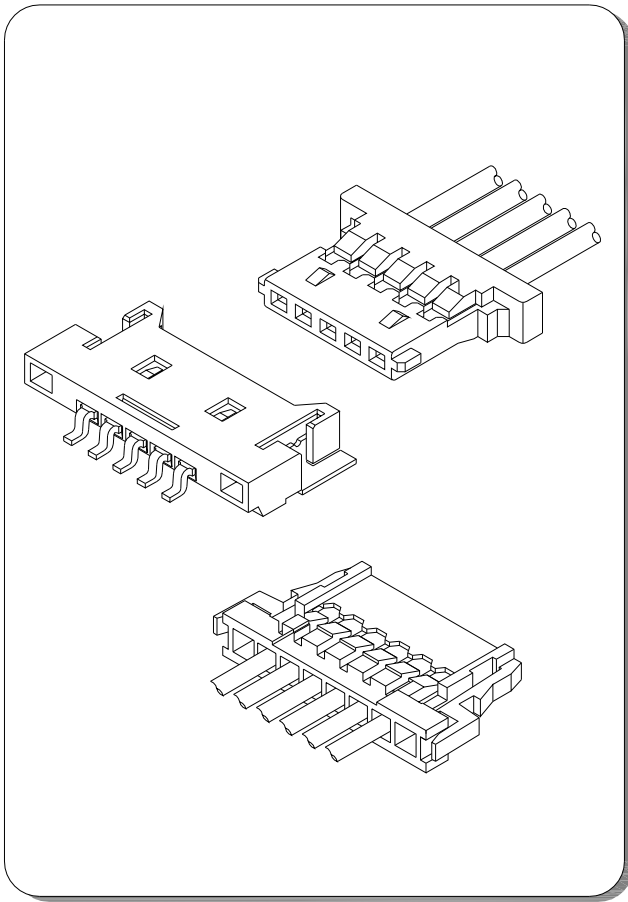

Specifications

Current rating:1A AC,DC
Voltage rating:125V AC,DC
Temperature range:-40°C~+105°C
Contact resistance:20mΩMax.
Insulation resistance:100MΩMin.
Withstanding voltage:500V AC/minute
Compliant with RoHS and REACH
Meet the HF/Halogen Free,need to customize
Contact for details

Standards



Assembly layout

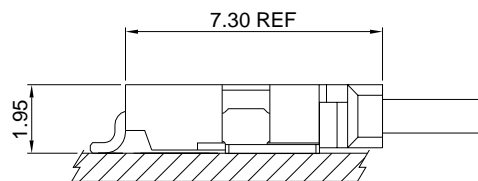

A1254 SERIES

1.25mm pitch wire to board connector

A1254-T

1.25mm pitch Crimp Terminal

Reference Informations:

*Used in A1254 series Housing

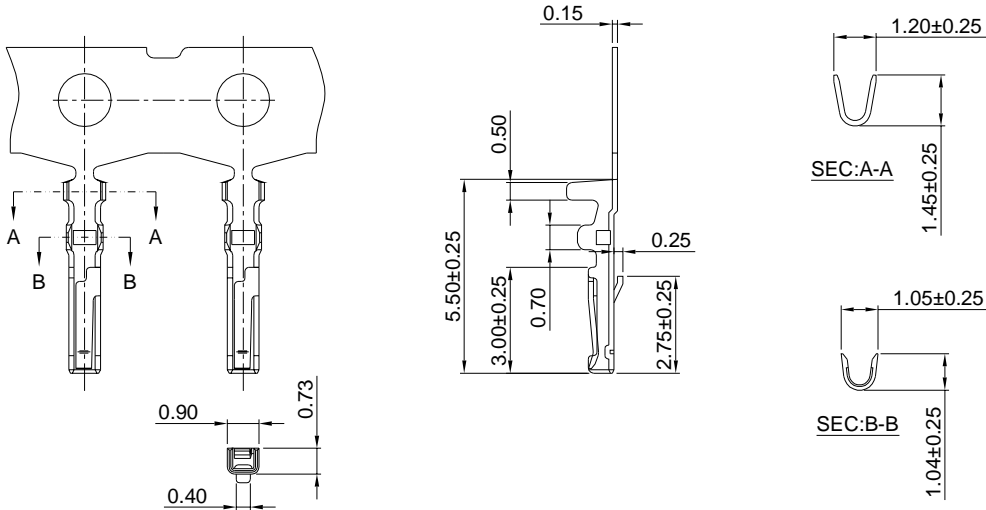

Ordering information & Specifications:

Unit:mm

Part NO.	Wire Range	Insulation O.D.	Material	Finish	Qty/reel
A1254-TP	AWG#28-#32	0.90mm(max)	Phosphor Bronze	Tin over Nickel	10,000 PCS
A1254-GP	AWG#28-#32	0.90mm(max)	Phosphor Bronze	Gold over Nickel	10,000 PCS

Optional Gold plating available but MOQ requested

A1254H

1.25mm pitch Housing

Reference Informations:

*Material:Nylon 66,UL94V-0

*Suitable A1254 series Terminal

*Mates with A1254 series Wafer

*Color:White

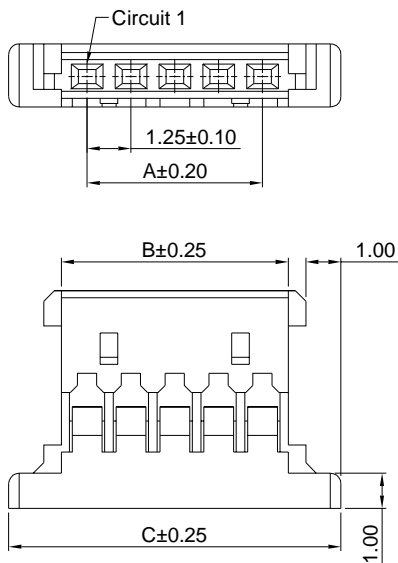
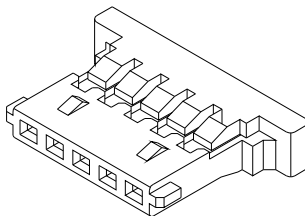

Ordering Information & Dimensions:

PART NO.	Dimensions			PART NO.	Dimensions		
	A	B	C		A	B	C
A1254H-2P	1.25	2.72	5.72	A1254H-17P	20.00	21.72	24.47
A1254H-3P	2.50	3.97	6.97	A1254H-18P	21.25	22.97	25.72
A1254H-4P	3.75	5.22	8.22	A1254H-19P	22.50	24.22	26.97
A1254H-5P	5.00	6.47	9.47	A1254H-20P	23.75	25.72	28.22
A1254H-6P	6.25	7.72	10.72	A1254H-21P	25.00	26.97	29.47
A1254H-7P	7.50	8.97	11.97	A1254H-22P	26.25	28.22	30.72
A1254H-8P	8.75	10.22	13.22	A1254H-23P	27.50	29.47	31.97
A1254H-9P	10.00	11.47	14.47	A1254H-24P	28.75	30.72	33.22
A1254H-10P	11.25	12.72	15.72	A1254H-25P	30.00	31.97	34.47
A1254H-11P	12.50	13.97	16.97	A1254H-26P	31.25	33.22	35.72
A1254H-12P	13.75	15.22	18.22	A1254H-27P	32.50	34.72	36.97
A1254H-13P	15.00	16.47	19.47	A1254H-28P	33.75	35.97	38.22
A1254H-14P	16.25	17.72	20.72	A1254H-29P	35.00	37.22	39.47
A1254H-15P	17.50	18.97	21.97	A1254H-30P	36.25	37.72	40.72
A1254H-16P	18.75	20.22	23.22				

Unit: mm

A1254 SERIES

1.25mm pitch wire to board connector

A1254HA

1.25mm pitch Housing

Reference Informations:

- *Material:Nylon 66,UL94V-0
- *Suitable A1254 series Terminal
- *Color:White

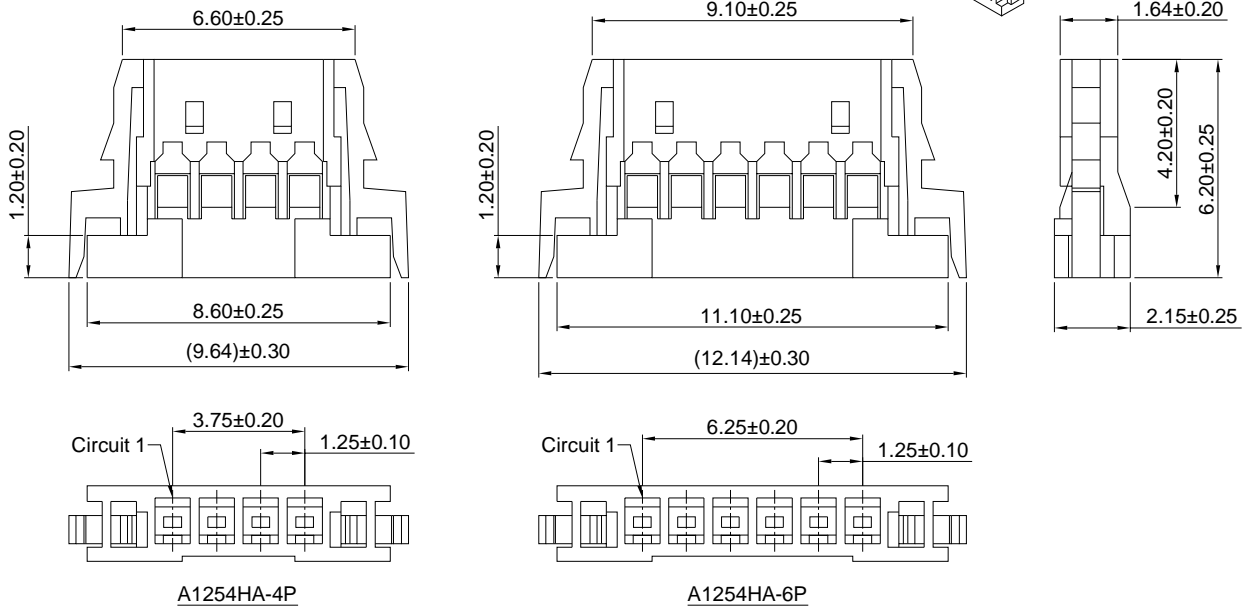
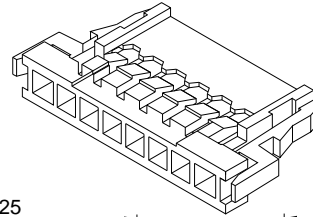

Unit: mm

A1254WR-S

1.25mm pitch 90° Wafer-SMT TYPE

Reference Informations:

- *Material:Pin:Brass/Tin over Nickel on solder area
Gold over Nickel on contact area
- Solder Tabs:Brass/Tin over Nickel
- Insulator:Nylon 6T,UL94V-0
- *Mates with A1254 series Housing
- *Color:Beige

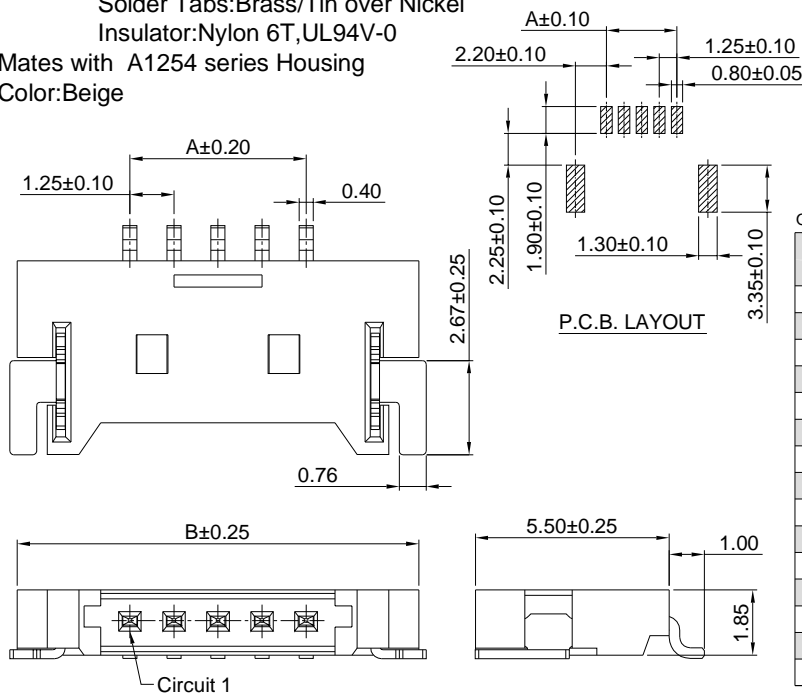
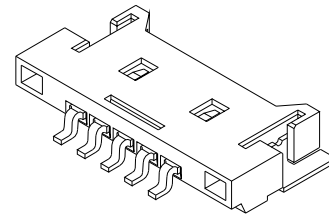

Ordering Information & Dimensions:

PART NO.	Dimensions		PART NO.	Dimensions	
	A	B		A	B
A1254WR-S-2P	1.25	7.65	A1254WR-S-17P	20.00	26.40
A1254WR-S-3P	2.50	8.90	A1254WR-S-18P	21.25	27.65
A1254WR-S-4P	3.75	10.15	A1254WR-S-19P	22.50	28.90
A1254WR-S-5P	5.00	11.40	A1254WR-S-20P	23.75	30.15
A1254WR-S-6P	6.25	12.65	A1254WR-S-21P	25.00	31.40
A1254WR-S-7P	7.50	13.90	A1254WR-S-22P	26.25	32.65
A1254WR-S-8P	8.75	15.15	A1254WR-S-23P	27.50	33.90
A1254WR-S-9P	10.00	16.40	A1254WR-S-24P	28.75	35.15
A1254WR-S-10P	11.25	17.65	A1254WR-S-25P	30.00	36.40
A1254WR-S-11P	12.50	18.90	A1254WR-S-26P	31.25	37.65
A1254WR-S-12P	13.75	20.15	A1254WR-S-27P	32.50	38.90
A1254WR-S-13P	15.00	21.40	A1254WR-S-28P	33.75	40.15
A1254WR-S-14P	16.25	22.65	A1254WR-S-29P	35.00	41.40
A1254WR-S-15P	17.50	23.90	A1254WR-S-30P	36.25	42.65
A1254WR-S-16P	18.75	25.15			

Unit: mm