

A2002 SERIES

2.00mm pitch wire to board connector

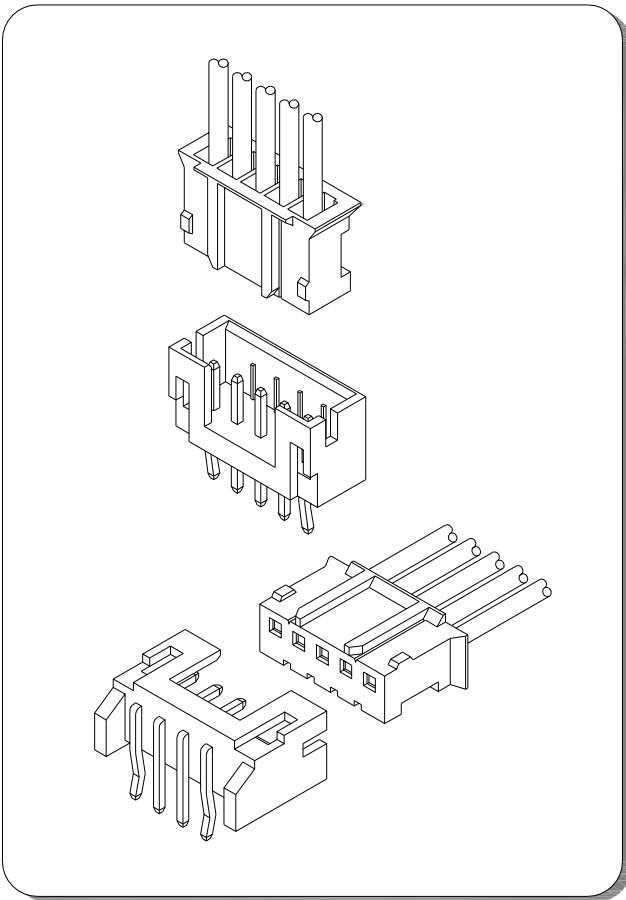

Specifications

- Current rating: 3A AC, DC
- Voltage rating: 300V AC, DC
- Temperature range: -40°C ~ +105°C
- Contact resistance: 20mΩ Max.
- Insulation resistance: 100MΩ Min.
- Withstanding voltage: 1000V AC/minute
- *Compliant with RoHS and REACH*
- *Meet the HF/Halogen Free, need to customize*
- *Contact for details*

Standards



Assembly layout

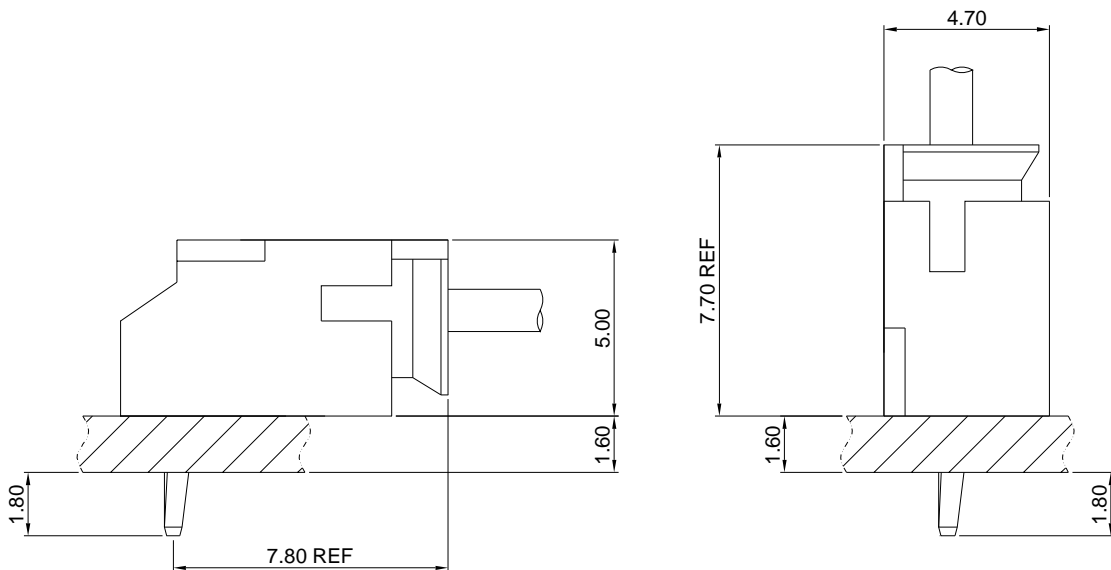

A2002 SERIES

2.00mm pitch wire to board connector

A2002-T

2.00mm pitch Crimp Terminal

Reference Informations:

*Used in A2002 series Housing

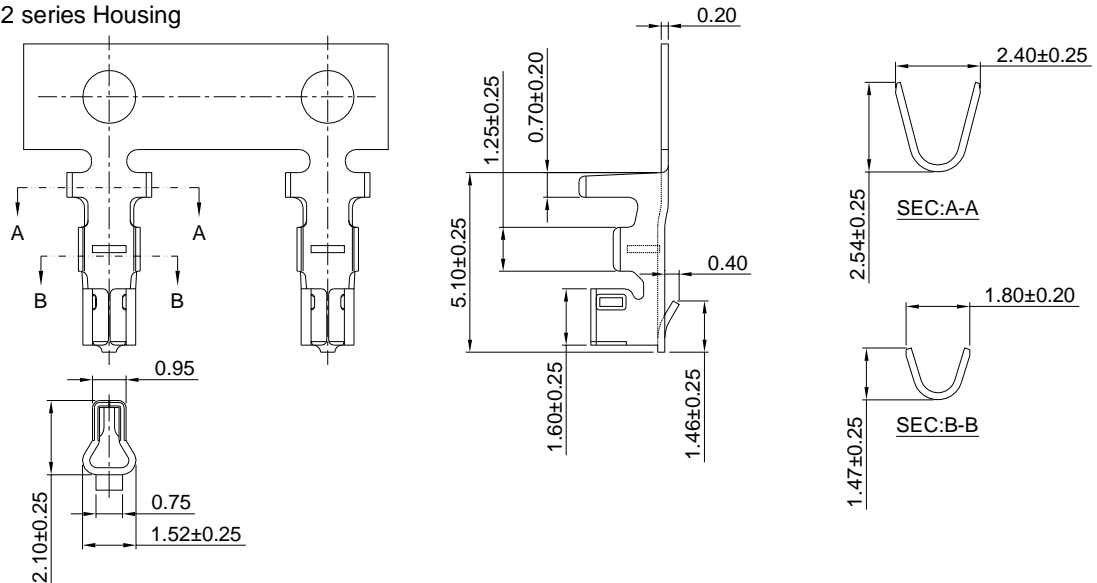

Ordering information & Specifications:

Unit:mm

Part NO	Wire Range	Insulation O.D.	Material	Finish	Qty/reel
A2002-TP	AWG#24-#28	1.50mm(max)	Phosphor Bronze	Tin over Nickel	10,000 PCS
A2002-GP	AWG#24-#28	1.50mm(max)	Phosphor Bronze	Gold over Nickel	10,000 PCS

Optional Gold plating available but MOQ requested

A2002H

2.00mm pitch Housing

Reference Informations:

*Material:Nylon 66,UL94V-0

*Suitable A2002 series Terminal

*Mates with A2002 series Wafer

*Color:Brown

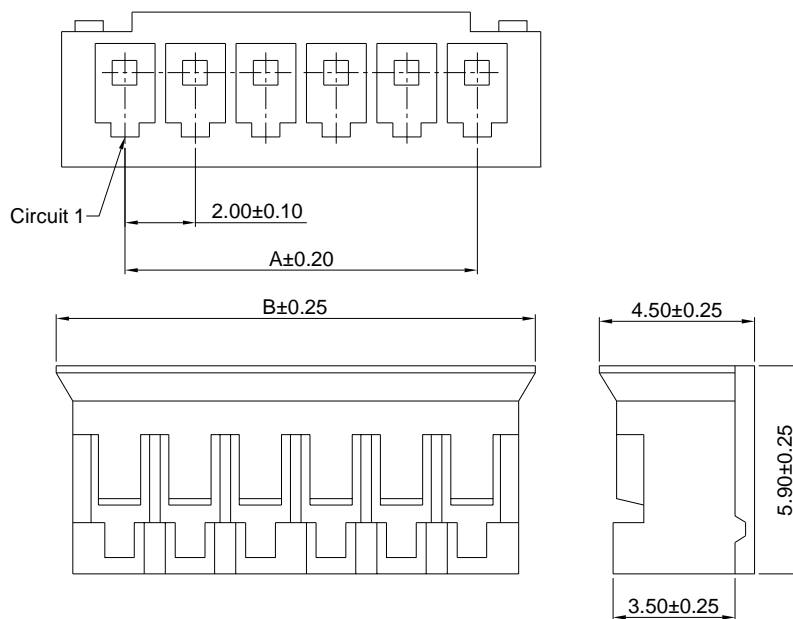
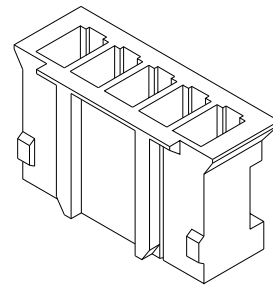

Ordering Information & Dimensions:

PART NO.	Dimensions	
	A	B
A2002H-2P	2.00	5.60
A2002H-3P	4.00	7.60
A2002H-4P	6.00	9.60
A2002H-5P	8.00	11.60
A2002H-6P	10.00	13.60
A2002H-7P	12.00	15.60
A2002H-8P	14.00	17.60
A2002H-9P	16.00	19.60
A2002H-10P	18.00	21.60
A2002H-11P	20.00	23.60
A2002H-12P	22.00	25.60
A2002H-13P	24.00	27.60
A2002H-14P	26.00	29.60
A2002H-15P	28.00	31.60

Unit: mm

A2002 SERIES

2.00mm pitch wire to board connector

A2002WV

2.00mm pitch 180° Wafer

Reference Informations:

- *Material:Pin:Brass/Tin over Nickel
Insulator:Nylon 66,UL94V-0
- *Mates with A2002 series Housing
- *Color:Brown

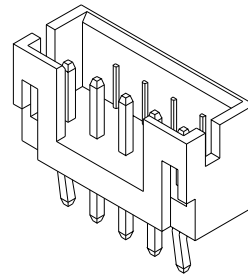
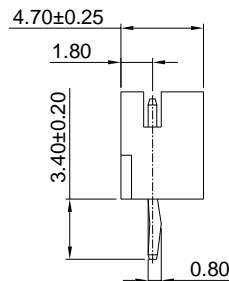
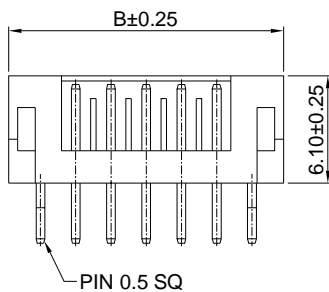
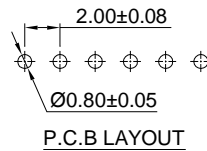
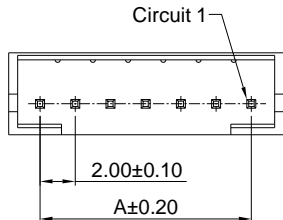

Ordering Information & Dimensions:

PART NO.	Dimensions	
	A	B
A2002WV-2P	2.00	6.00
A2002WV-3P	4.00	8.00
A2002WV-4P	6.00	10.00
A2002WV-5P	8.00	12.00
A2002WV-6P	10.00	14.00
A2002WV-7P	12.00	16.00
A2002WV-8P	14.00	18.00
A2002WV-9P	16.00	20.00
A2002WV-10P	18.00	22.00
A2002WV-11P	20.00	24.00
A2002WV-12P	22.00	26.00
A2002WV-13P	24.00	28.00
A2002WV-14P	26.00	30.00
A2002WV-15P	28.00	32.00

Unit: mm

A2002WR

2.00mm pitch 90° Wafer

Reference Informations:

- *Material:Pin:Brass/Tin over Nickel
Wafer:Nylon 66,UL94V-0
- *Mates with A2002 series Housing
- *Color:Brown

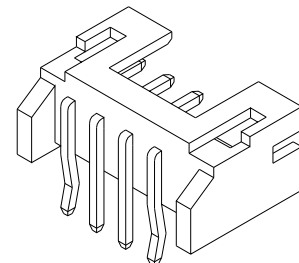
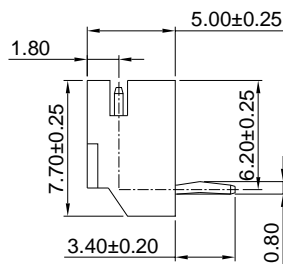
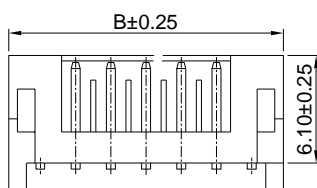
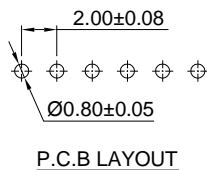
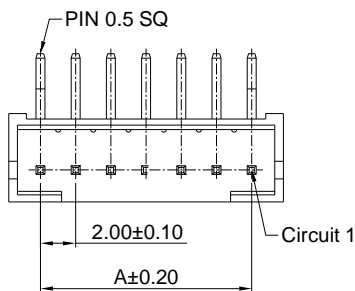

Ordering Information & Dimensions:

PART NO.	Dimensions	
	A	B
A2002WR-2P	2.00	6.00
A2002WR-3P	4.00	8.00
A2002WR-4P	6.00	10.00
A2002WR-5P	8.00	12.00
A2002WR-6P	10.00	14.00
A2002WR-7P	12.00	16.00
A2002WR-8P	14.00	18.00
A2002WR-9P	16.00	20.00
A2002WR-10P	18.00	22.00
A2002WR-11P	20.00	24.00
A2002WR-12P	22.00	26.00
A2002WR-13P	24.00	28.00
A2002WR-14P	26.00	30.00
A2002WR-15P	28.00	32.00

Unit: mm