

A2004 SERIES

2.00mm pitch wire to board connector

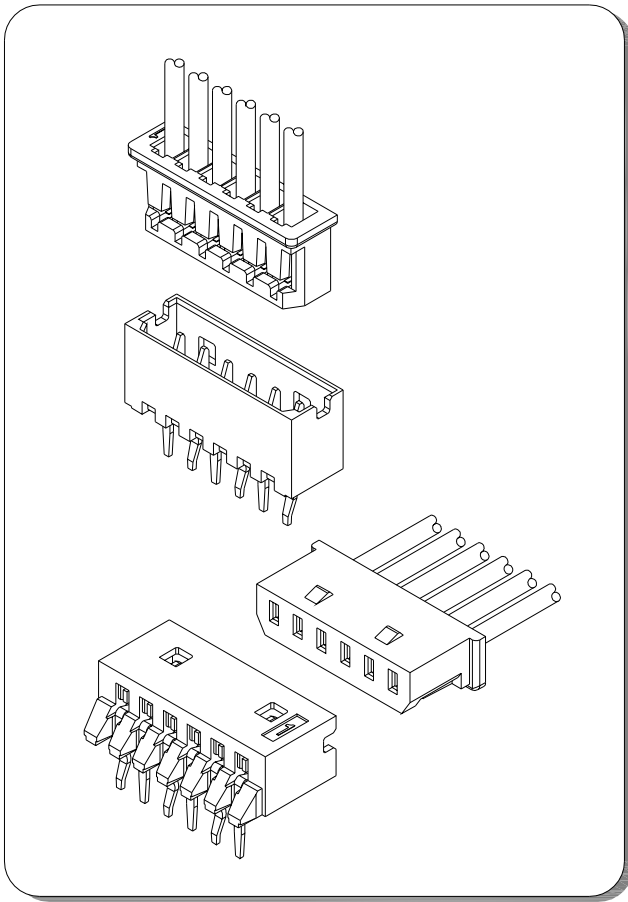

Specifications

- Current rating: 2A AC, DC
- Voltage rating: 125V AC, DC
- Temperature range: -40°C ~ +105°C
- Contact resistance: 20mΩ Max.
- Insulation resistance: 1000MΩ Min.
- Withstanding voltage: 800V AC/minute
- *Compliant with RoHS and REACH*
- *Meet the HF/Halogen Free, need to customize*
- *Contact for details*

Standards



Assembly layout

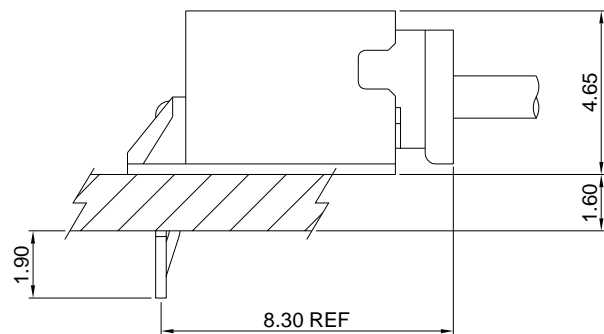
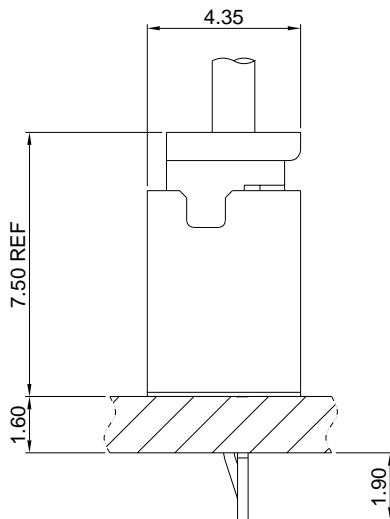

A2004 SERIES

2.00mm pitch wire to board connector

A2004-T

2.00mm pitch Crimp Terminal

Reference Informations:

*Used in A2004 series Housing

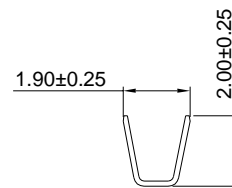
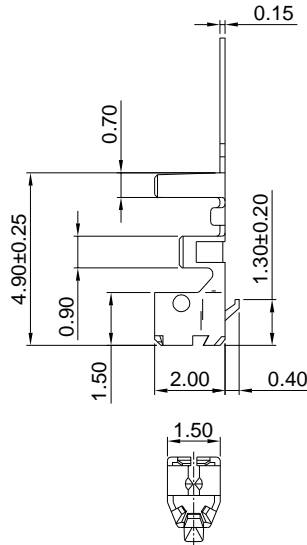
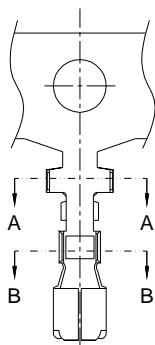

SEC:A-A

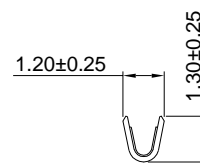

SEC:B-B

Ordering information & Specifications:

Unit:mm

Part NO.	Wire Range	Insulation O.D.	Material	Finish	Qty/reel
A2004-TP	AWG#24-#28	1.40mm(max)	Phosphor Bronze	Tin over Nickel	10,000 PCS
A2004-GP	AWG#24-#28	1.40mm(max)	Phosphor Bronze	Gold over Nickel	10,000 PCS

Optional Gold plating available but MOQ requested

A2004H

2.00mm pitch Housing

Reference Informations:

*Material:Nylon 66,UL94V-0

*Suitable A2004 series Terminal

*Mates with A2004 series Wafer

*Color:White

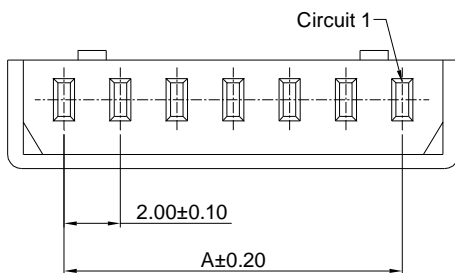

3~15P

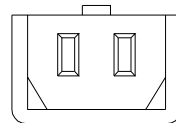

2P

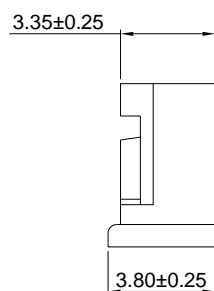
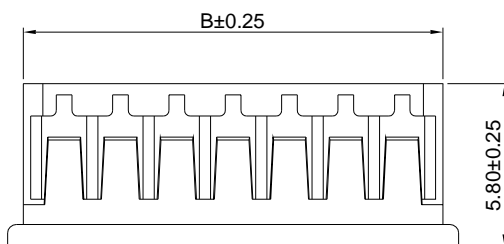
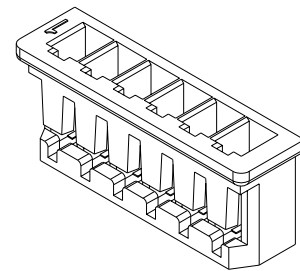

Ordering Information & Dimensions:

PART NO.	Dimensions	
	A	B
A2004H-2P	2.00	5.90
A2004H-3P	4.00	7.90
A2004H-4P	6.00	9.90
A2004H-5P	8.00	11.90
A2004H-6P	10.00	13.90
A2004H-7P	12.00	15.90
A2004H-8P	14.00	17.90
A2004H-9P	16.00	19.90
A2004H-10P	18.00	21.90
A2004H-11P	20.00	23.90
A2004H-12P	22.00	25.90
A2004H-13P	24.00	27.90
A2004H-14P	26.00	29.90
A2004H-15P	28.00	31.90

Unit: mm

A2004 SERIES

2.00mm pitch wire to board connector

A2004WV

2.00mm pitch 180° Wafer

Reference Informations:

- *Material:Pin:Phosphor Bronze/Tin over Nickel
Insulator:Nylon 66,UL94V-0
- *Mates with A2004 series Housing
- *Color:Ivory

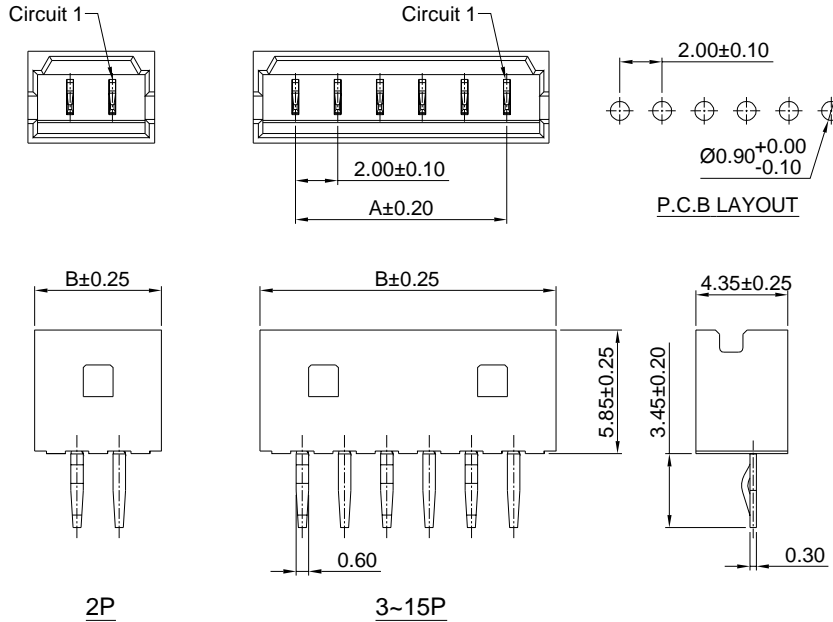

Ordering Information & Dimensions:

PART NO.	Dimensions	
	A	B
A2004WV-2P	2.00	6.00
A2004WV-3P	4.00	8.00
A2004WV-4P	6.00	10.00
A2004WV-5P	8.00	12.00
A2004WV-6P	10.00	14.00
A2004WV-7P	12.00	16.00
A2004WV-8P	14.00	18.00
A2004WV-9P	16.00	20.00
A2004WV-10P	18.00	22.00
A2004WV-11P	20.00	24.00
A2004WV-12P	22.00	26.00
A2004WV-13P	24.00	28.00
A2004WV-14P	26.00	30.00
A2004WV-15P	28.00	32.00

Unit: mm

A2004WR

2.00mm pitch 90° Wafer

Reference Informations:

- *Material:Pin:Phosphor Bronze/Tin over Nickel
Insulator:Nylon 66,UL94V-0
- *Mates with A2004 series Housing
- *Color:Ivory

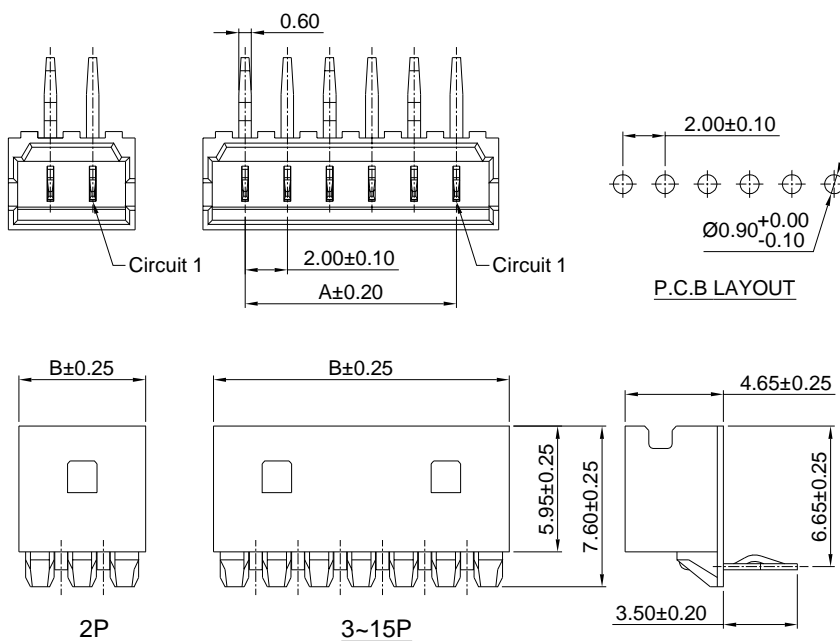

Ordering Information & Dimensions:

PART NO.	Dimensions	
	A	B
A2004WR-2P	2.00	6.00
A2004WR-3P	4.00	8.00
A2004WR-4P	6.00	10.00
A2004WR-5P	8.00	12.00
A2004WR-6P	10.00	14.00
A2004WR-7P	12.00	16.00
A2004WR-8P	14.00	18.00
A2004WR-9P	16.00	20.00
A2004WR-10P	18.00	22.00
A2004WR-11P	20.00	24.00
A2004WR-12P	22.00	26.00
A2004WR-13P	24.00	28.00
A2004WR-14P	26.00	30.00
A2004WR-15P	28.00	32.00

Unit: mm