

A2011 SERIES

2.00mm pitch wire to board connector

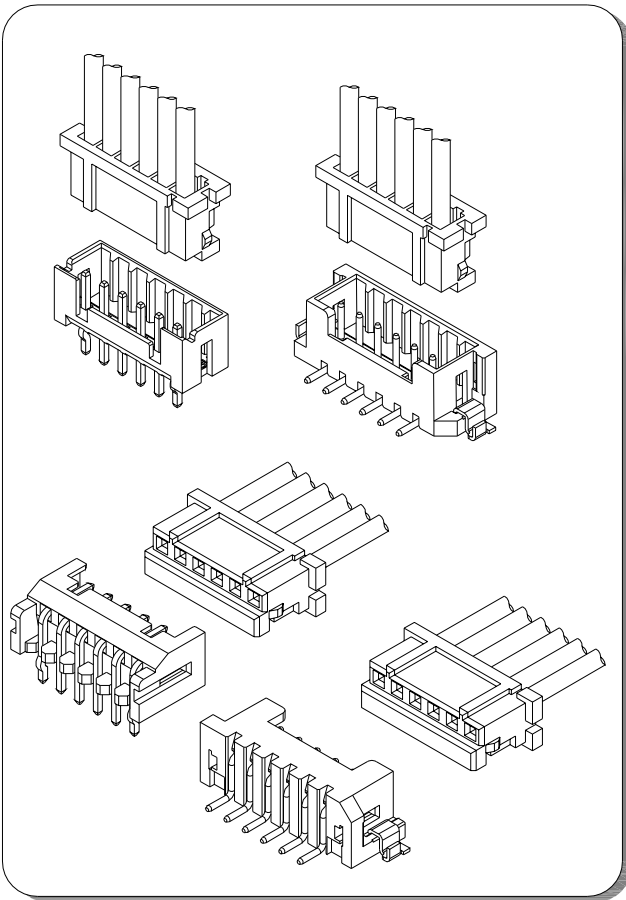

Specifications

- Current rating: 3A AC, DC
- Voltage rating: 250V AC, DC
- Temperature range: -40°C ~ +105°C
- Contact resistance: 30mΩ Max.
- Insulation resistance: 650MΩ Min.
- Withstanding voltage: 800V AC/minute
- *Compliant with RoHS and REACH*
- *Meet the HF/Halogen Free, need to customize*
- *Contact for details*

Standards



Assembly layout

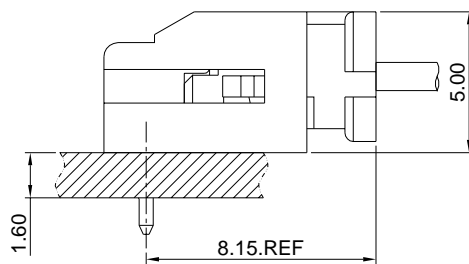

DIP TYPE

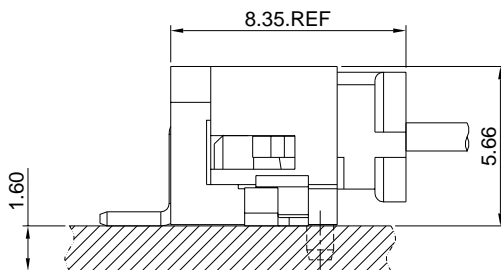
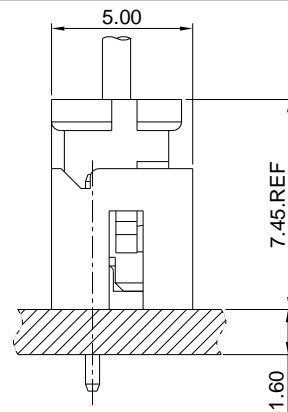

SMT TYPE

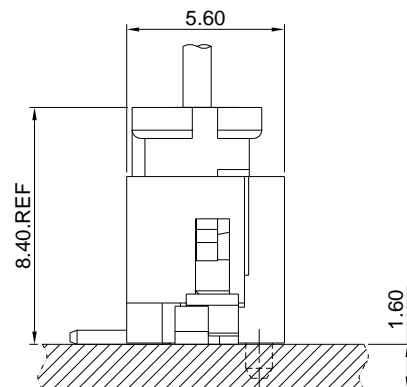

A2011 SERIES

2.00mm pitch wire to board connector

A2011-T

2.00mm pitch Crimp Terminal

Reference Informations:

*Used in A2011 series Housing

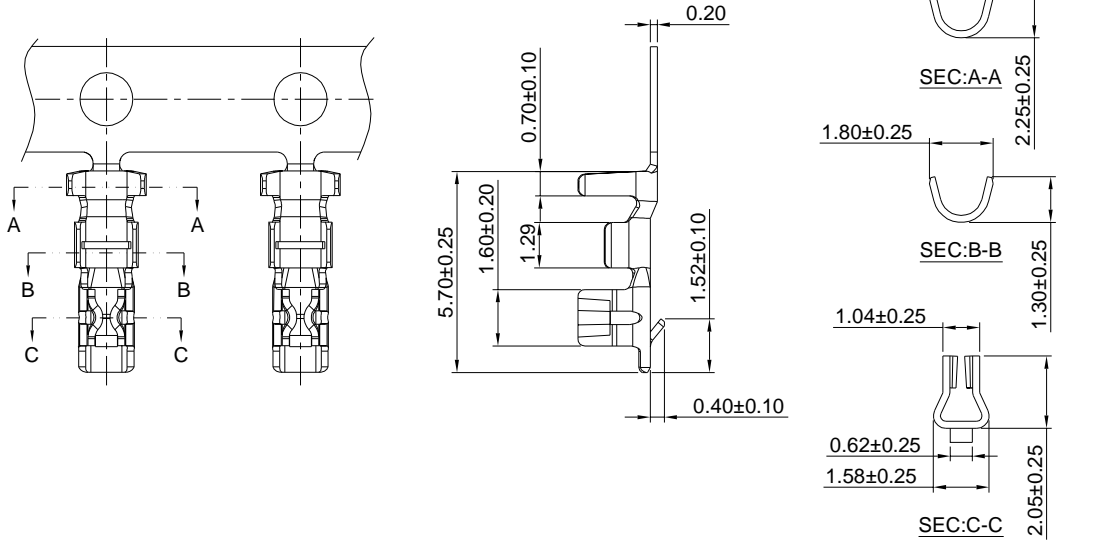

Ordering information & Specifications:

Unit:mm

Part NO	Wire Range	Insulation O.D.	Material	Finish	Qty/reel
A2011-TP	AWG#22-#28	1.45mm(max)	Phosphor Bronze	Tin over Nickel	10,000 PCS
A2011-GP	AWG#22-#28	1.45mm(max)	Phosphor Bronze	Gold over Nickel	10,000 PCS

Optional Gold plating available but MOQ requested

A2011H

2.00mm pitch Housing

Reference Informations:

*Material:Nylon 66,UL94V-0

*Suitable A2011 series Terminal

*Mates with A2011 series Wafer

*Color:Black

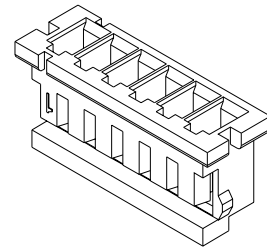
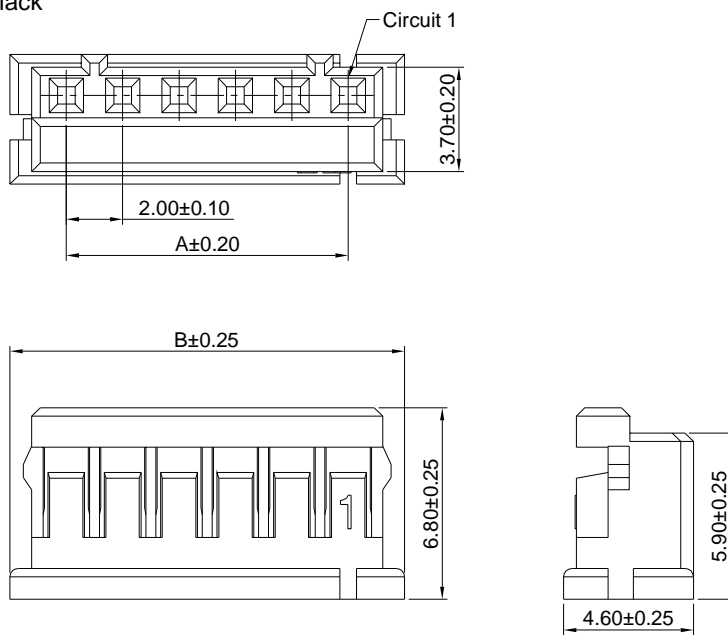

Ordering Information & Dimensions

PART NO.	Dimensions	
	A	B
A2011H-2P	2.00	6.00
A2011H-3P	4.00	8.00
A2011H-4P	6.00	10.00
A2011H-5P	8.00	12.00
A2011H-6P	10.00	14.00
A2011H-7P	12.00	16.00
A2011H-8P	14.00	18.00
A2011H-9P	16.00	20.00
A2011H-10P	18.00	22.00
A2011H-11P	20.00	24.00
A2011H-12P	22.00	26.00
A2011H-13P	24.00	28.00
A2011H-14P	26.00	28.00
A2011H-15P	28.00	30.00

Unit: mm

A2011 SERIES

2.00mm pitch wire to board connector

A2011WV

2.00mm pitch 180° Wafer

Reference Informations:

- *Material:Pin:Brass/Tin over Nickel
Insulator:Nylon 66,UL94V-0
- *Mates with A2011 series Housing
- *Color:Black

Ordering Information:

- A2011WV-XP - **
1 2
- 1.Part No.
 - 2.Finish:
(blank):Tin over Nickel
G:Gold over Nickel

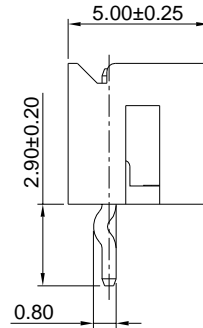
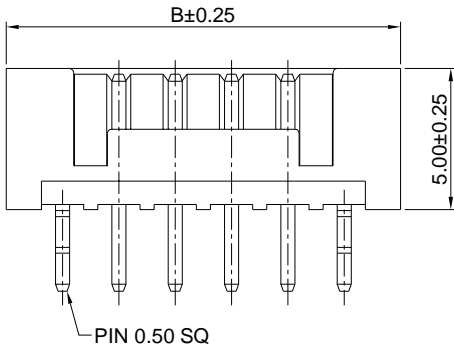
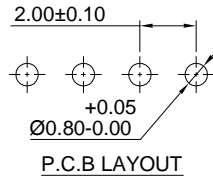
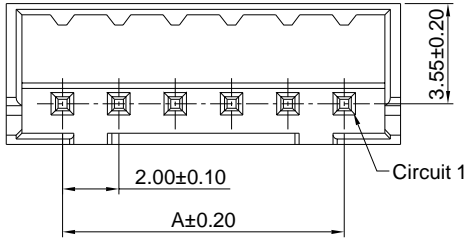
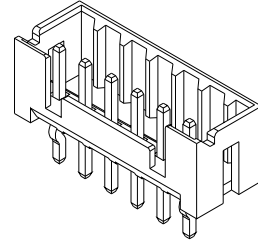

Ordering Information & Dimensions

PART NO.	Dimensions	
	A	B
A2011WV-2P	2.00	6.00
A2011WV-3P	4.00	8.00
A2011WV-4P	6.00	10.00
A2011WV-5P	8.00	12.00
A2011WV-6P	10.00	14.00
A2011WV-7P	12.00	16.00
A2011WV-8P	14.00	18.00
A2011WV-9P	16.00	20.00
A2011WV-10P	18.00	22.00
A2011WV-11P	20.00	24.00
A2011WV-12P	22.00	26.00
A2011WV-13P	24.00	28.00
A2011WV-14P	26.00	28.00
A2011WV-15P	28.00	30.00

Unit: mm

A2011WR

2.00mm pitch 90° Wafer

Reference Informations:

- *Material:Pin:Brass/Tin over Nickel
Insulator:Nylon 66,UL94V-0
- *Mates with A2011 series Housing
- *Color:Black

Ordering Information:

- A2011WR-XP - **
1 2
- 1.Part No.
 - 2.Finish:
(blank):Tin over Nickel
G:Gold over Nickel

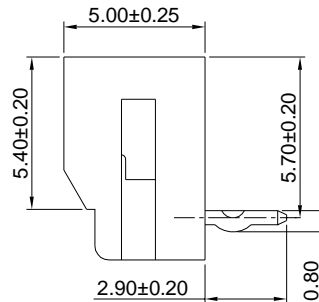
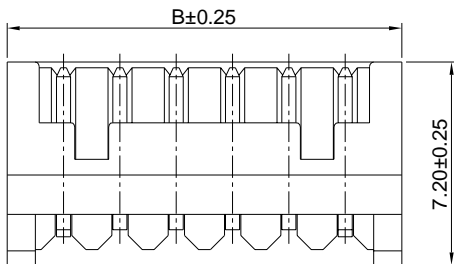
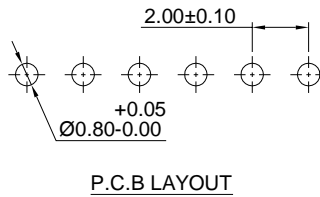
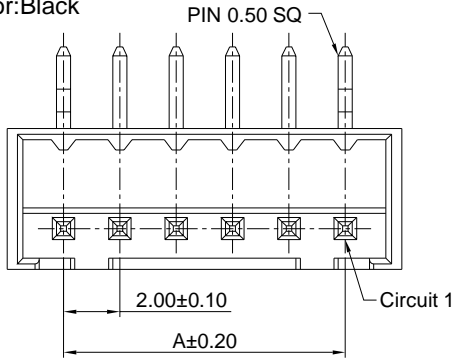
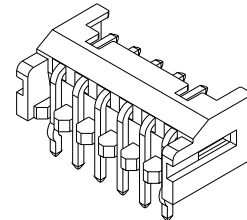

Ordering Information & Dimensions

PART NO.	Dimensions	
	A	B
A2011WR-2P	2.00	6.00
A2011WR-3P	4.00	8.00
A2011WR-4P	6.00	10.00
A2011WR-5P	8.00	12.00
A2011WR-6P	10.00	14.00
A2011WR-7P	12.00	16.00
A2011WR-8P	14.00	18.00
A2011WR-9P	16.00	20.00
A2011WR-10P	18.00	22.00
A2011WR-11P	20.00	24.00
A2011WR-12P	22.00	26.00
A2011WR-13P	24.00	28.00
A2011WR-14P	26.00	28.00
A2011WR-15P	28.00	30.00

Unit: mm

A2011 SERIES

2.00mm pitch wire to board connector

A2011WV-S

2.00mm pitch 180° Wafer-SMT TYPE

Reference Informations:

- *Material:Pin:Brass/Tin over Nickel
Solder Tabs: Brass/Tin over Nickel
Insulator:Nylon 6T,UL94V-0
- *Mates with A2011 series Housing
- *Color:Ivory

Ordering Information:

- A2011WV-S-XP - **
1 2
- 1.Part No.
 - 2.Finish:
(blank):Tin over Nickel
G:Gold over Nickel

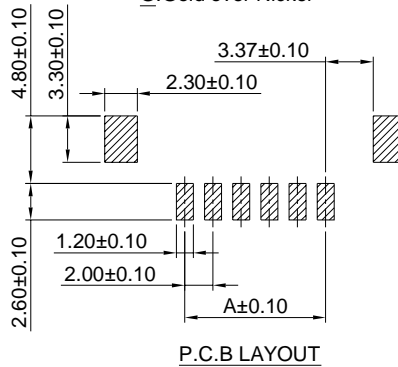
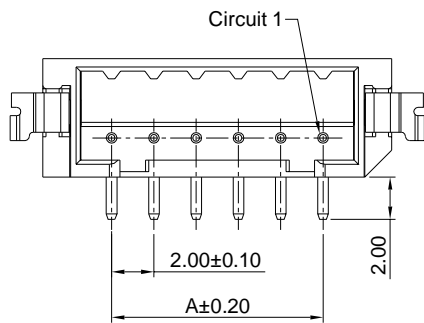
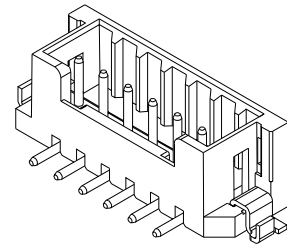

Ordering Information & Dimensions

PART NO.	Dimensions	
	A	B
A2011WV-S-2P	2.00	8.50
A2011WV-S-3P	4.00	10.50
A2011WV-S-4P	6.00	12.50
A2011WV-S-5P	8.00	14.50
A2011WV-S-6P	10.00	16.50
A2011WV-S-7P	12.00	18.50
A2011WV-S-8P	14.00	20.50
A2011WV-S-9P	16.00	22.50
A2011WV-S-10P	18.00	24.50
A2011WV-S-11P	20.00	26.50
A2011WV-S-12P	22.00	28.50
A2011WV-S-13P	24.00	28.50
A2011WV-S-14P	26.00	30.50
A2011WV-S-15P	28.00	32.50

Unit: mm

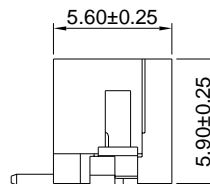
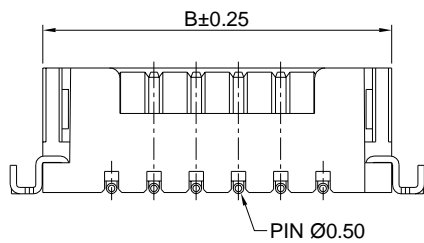

A2011WR-S

2.00mm pitch 90° Wafer-SMT TYPE

Reference Informations:

- *Material:Pin:Brass/Tin over Nickel
Solder Tabs: Brass/Tin over Nickel
Insulator:Nylon 6T,UL94V-0
- *Mates with A2011 series Housing
- *Color:Ivory

Ordering Information:

- A2011WR-S-XP - **
1 2
- 1.Part No.
 - 2.Finish:
(blank):Tin over Nickel
G:Gold over Nickel

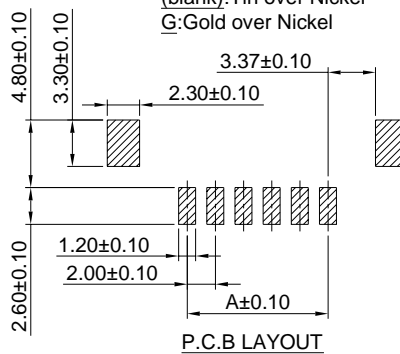
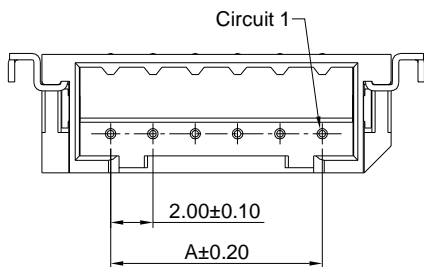
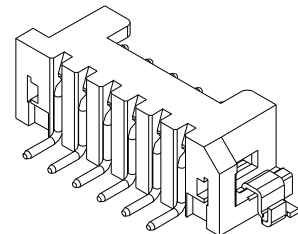

Ordering Information & Dimensions

PART NO.	Dimensions	
	A	B
A2011WR-S-2P	2.00	8.50
A2011WR-S-3P	4.00	10.50
A2011WR-S-4P	6.00	12.50
A2011WR-S-5P	8.00	14.50
A2011WR-S-6P	10.00	16.50
A2011WR-S-7P	12.00	18.50
A2011WR-S-8P	14.00	20.50
A2011WR-S-9P	16.00	22.50
A2011WR-S-10P	18.00	24.50
A2011WR-S-11P	20.00	26.50
A2011WR-S-12P	22.00	28.50
A2011WR-S-13P	24.00	28.50
A2011WR-S-14P	26.00	30.50
A2011WR-S-15P	28.00	32.50

Unit: mm

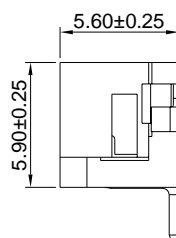
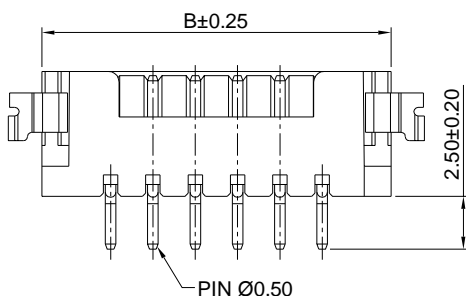

A2011 SERIES

2.00mm pitch wire to board connector

A2011WV-S-F

2.00mm pitch 180° Wafer Boss-SMT TYPE

Reference Informations:

- *Material:Pin:Brass/Tin over Nickel
Solder Tabs: Brass/Tin over Nickel
Insulator:Nylon 6T,UL94V-0
- *Mates with A2011 series Housing
- *Color:Ivory

Ordering Information:

- A2011WV-S-F-XP - **
- 1 2
- 1.Part No.
 - 2.Finish:
(blank):Tin over Nickel
G:Gold over Nickel

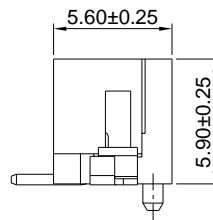
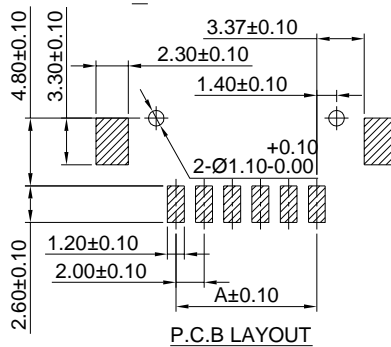
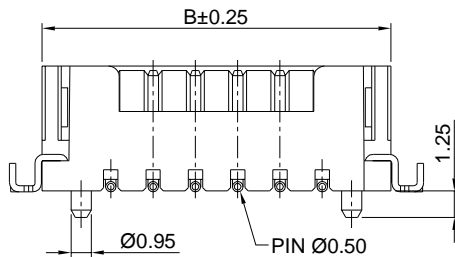
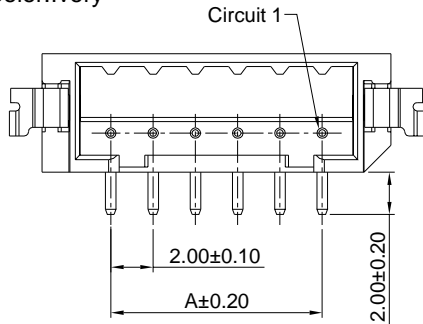
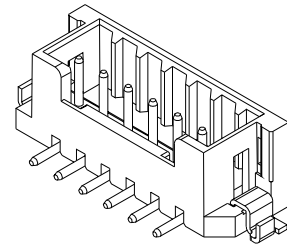

Ordering Information & Dimensions

PART NO.	Dimensions	
	A	B
A2011WV-S-F-2P	2.00	8.50
A2011WV-S-F-3P	4.00	10.50
A2011WV-S-F-4P	6.00	12.50
A2011WV-S-F-5P	8.00	14.50
A2011WV-S-F-6P	10.00	16.50
A2011WV-S-F-7P	12.00	18.50
A2011WV-S-F-8P	14.00	20.50
A2011WV-S-F-9P	16.00	22.50
A2011WV-S-F-10P	18.00	24.50
A2011WV-S-F-11P	20.00	26.50
A2011WV-S-F-12P	22.00	28.50
A2011WV-S-F-13P	24.00	28.50
A2011WV-S-F-14P	26.00	30.50
A2011WV-S-F-15P	28.00	32.50

Unit: mm

A2011WR-S-F

2.00mm pitch 90° Wafer Boss-SMT TYPE

Reference Informations:

- *Material:Pin:Brass/Tin over Nickel
Solder Tabs: Brass/Tin over Nickel
Insulator:Nylon 6T,UL94V-0
- *Mates with A2011 series Housing
- *Color:Ivory

Ordering Information:

- A2011WR-S-F-XP - **
- 1 2
- 1.Part No.
 - 2.Finish:
(blank):Tin over Nickel
G:Gold over Nickel

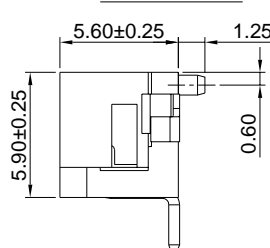
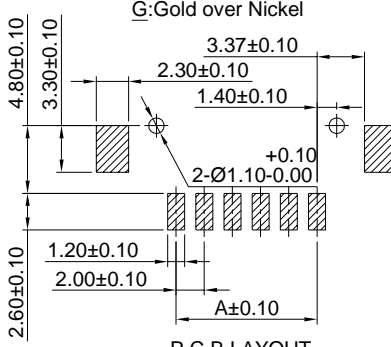
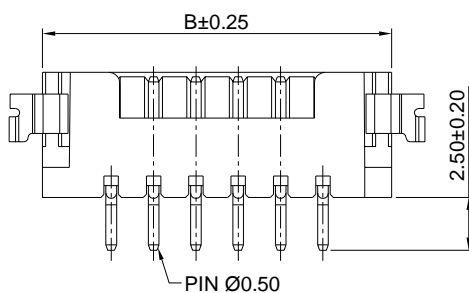
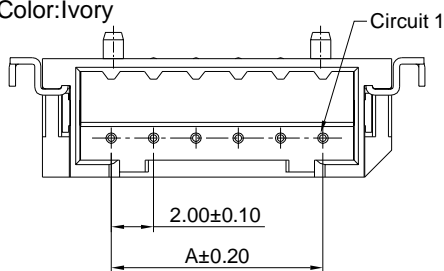
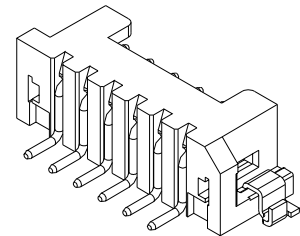

Ordering Information & Dimensions

PART NO.	Dimensions	
	A	B
A2011WR-S-F-2P	2.00	8.50
A2011WR-S-F-3P	4.00	10.50
A2011WR-S-F-4P	6.00	12.50
A2011WR-S-F-5P	8.00	14.50
A2011WR-S-F-6P	10.00	16.50
A2011WR-S-F-7P	12.00	18.50
A2011WR-S-F-8P	14.00	20.50
A2011WR-S-F-9P	16.00	22.50
A2011WR-S-F-10P	18.00	24.50
A2011WR-S-F-11P	20.00	26.50
A2011WR-S-F-12P	22.00	28.50
A2011WR-S-F-13P	24.00	28.50
A2011WR-S-F-14P	26.00	30.50
A2011WR-S-F-15P	28.00	32.50

Unit: mm