

A2501 SERIES 2.50mm pitch wire to board and wire to wire connector

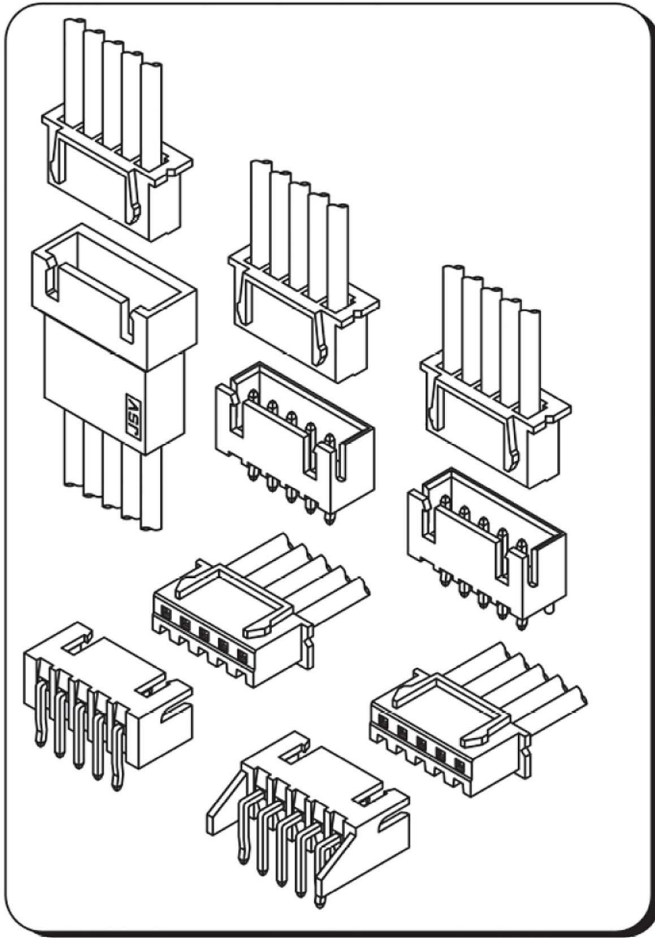

Specifications

- Current rating:3A AC,DC
- Voltage rating:250V AC,DC
- Temperature range:-40°C~+105°C
- Contact resistance:10mΩMax.
- Insulation resistance:1000MΩMin.
- Withstanding voltage:800V AC/minute
- *Compliant with RoHS and REACH*
- *Meet the HF/Halogen Free,need to customize*
- *Contact for details*

Standards



Assembly layout

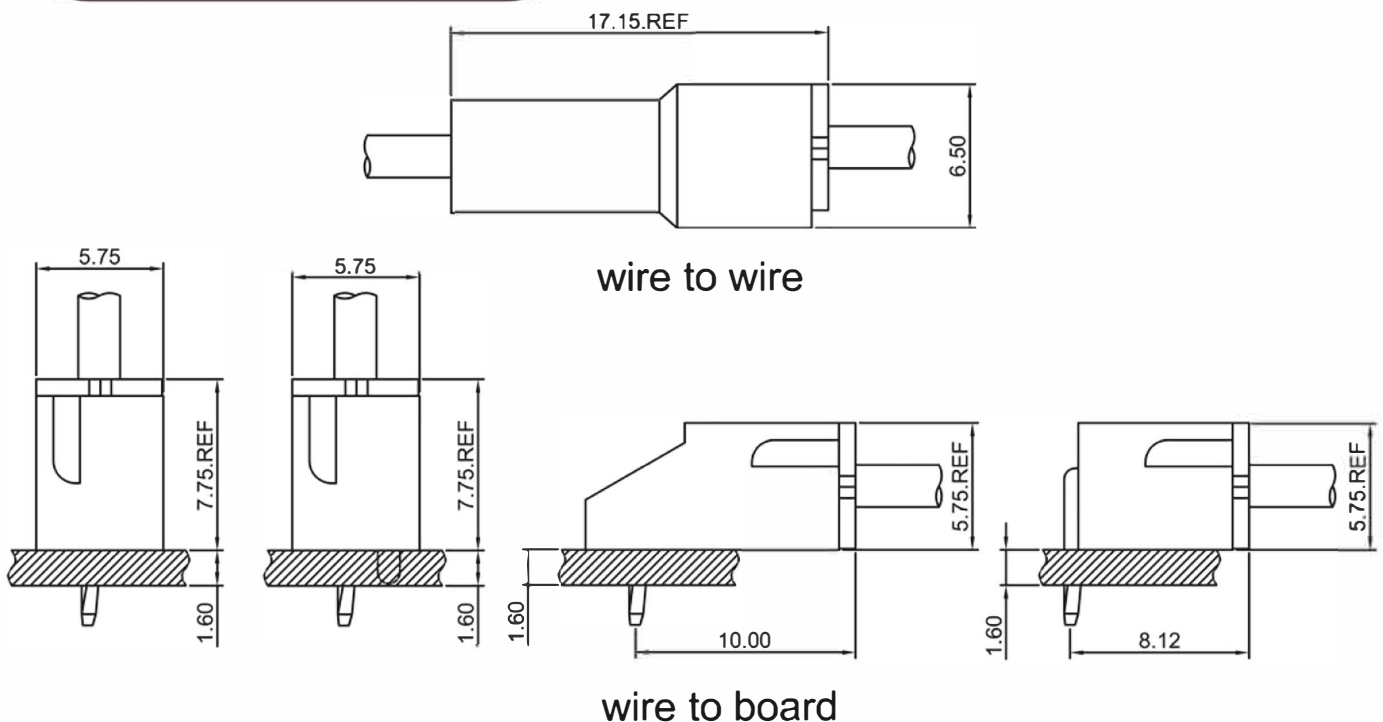

A2501 SERIES 2.50mm pitch wire to board and wire to wire connector

A2501H-T

2.50mm pitch Crimp Terminal

Reference Informations:

*Used in A2501H series Housing

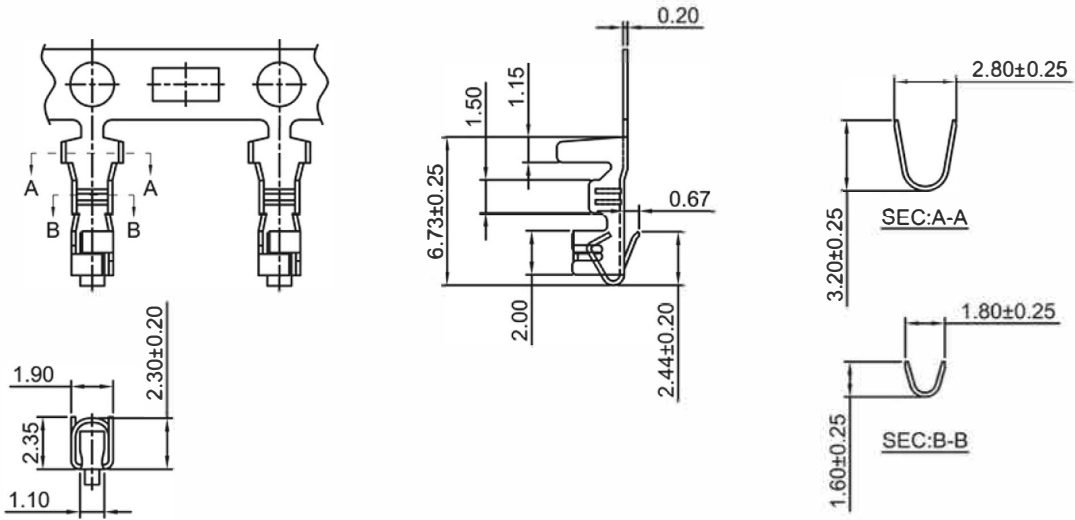

Ordering information & Specifications:

Unit:mm

Part NO.	Wire Range	Insulation O.D.	Material	Finish	Qty/reel
A2501H-TB	AWG#22-#28	1.90mm(max)	Brass	Tin over Nickel	8,000 PCS
A2501H-TP	AWG#22-#28	1.90mm(max)	Phosphor Bronze	Tin over Nickel	8,000 PCS
A2501H-GB	AWG#22-#28	1.90mm(max)	Brass	Gold over Nickel	8,000 PCS
A2501H-GP	AWG#22-#28	1.90mm(max)	Phosphor Bronze	Gold over Nickel	8,000 PCS

Optional Gold plating available but MOQ requested

A2501M-T

2.50mm pitch Crimp Terminal

Reference Informations:

*Used in A2501HM series Housing

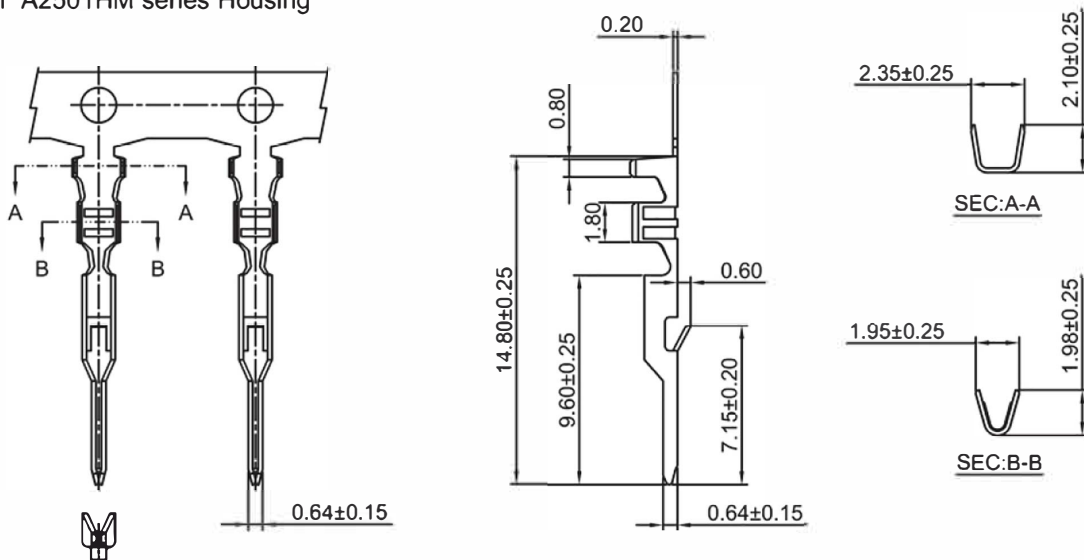

Ordering information & Specifications:

Unit:mm

Part NO.	Wire Range	Insulation O.D.	Material	Finish	Qty/reel
A2501M-TB	AWG#22-#28	1.00mm(max)	Brass	Tin over Nickel	10,000 PCS
A2501M-TP	AWG#22-#28	1.00mm(max)	Phosphor Bronze	Tin over Nickel	10,000 PCS
A2501M-GB	AWG#22-#28	1.00mm(max)	Brass	Gold over Nickel	10,000 PCS
A2501M-GP	AWG#22-#28	1.00mm(max)	Phosphor Bronze	Gold over Nickel	10,000 PCS

A2501 SERIES 2.50mm pitch wire to board and wire to wire connector

A2501H

—2.50mm pitch Housing—

Reference Informations:

- *Material:Nylon 66,UL94V-0
- *Suitable A2501H-T series Terminal
- *Mates with A2501WV , A2501WV-F , A2501WR , A2501WRB , A2501WVR , A2501WV-S , A2501WR-S series Wafer
- *Color: White

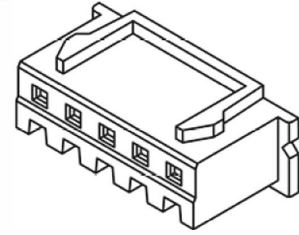

Ordering Information:

A2501H-NP - **
1 2

- 1.Part No
- 2.Color:
(blank):White
BL:Blue
BK:Black
RD:Red
YL:Yellow
GN:Green

Ordering Information & Dimensions:

PART NO.	Dimensions	
	A	B
A2501H-02P	2.50	5.70
A2501H-03P	5.00	8.20
A2501H-04P	7.50	10.70
A2501H-05P	10.00	13.20
A2501H-06P	12.50	15.70
A2501H-07P	15.00	18.20
A2501H-08P	17.50	20.70
A2501H-09P	20.00	23.20
A2501H-10P	22.50	25.70
A2501H-11P	25.00	28.20
A2501H-12P	27.50	30.70
A2501H-13P	30.00	33.20
A2501H-14P	32.50	35.70
A2501H-15P	35.00	38.20
A2501H-16P	37.50	40.70
A2501H-17P	40.00	43.20
A2501H-18P	42.50	45.70
A2501H-19P	45.00	48.20
A2501H-20P	47.50	50.70

Unit: mm

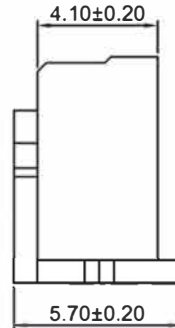
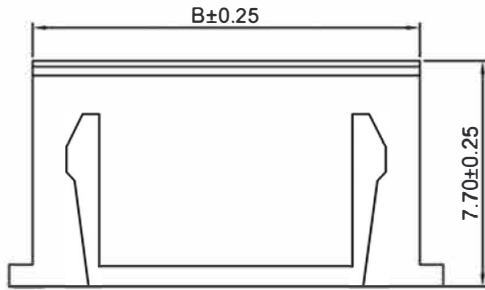
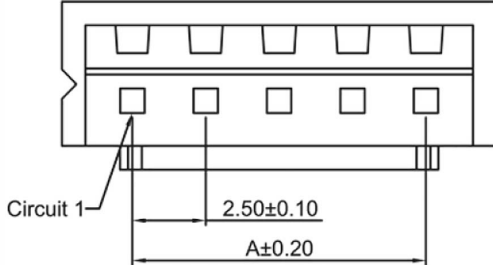

A2501HM

—2.50mm pitch Housing—

Reference Informations:

- *Material:Nylon 66,UL94V-0
- *Suitable A2501M-T series Terminal
- *Mates with A2501 H series Housing
- *Color:White

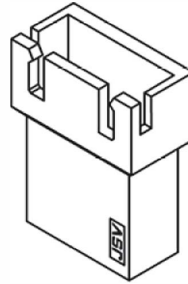

Ordering Information & Dimensions:

PART NO.	Dimensions	
	A	B
A2501HM-02P	2.50	7.50
A2501HM-03P	5.00	10.00
A2501HM-04P	7.50	12.50
A2501HM-05P	10.00	15.00
A2501HM-06P	12.50	17.50
A2501HM-07P	15.00	20.00
A2501HM-08P	17.50	22.50
A2501HM-09P	20.00	25.00
A2501HM-10P	22.50	27.50
A2501HM-11P	25.00	30.00
A2501HM-12P	27.50	32.50
A2501HM-13P	30.00	35.00
A2501HM-14P	32.50	37.50
A2501HM-15P	35.00	40.00
A2501HM-16P	37.50	42.50
A2501HM-17P	40.00	45.00
A2501HM-18P	42.50	47.50
A2501HM-19P	45.00	50.00
A2501HM-20P	47.50	52.50

Unit: mm

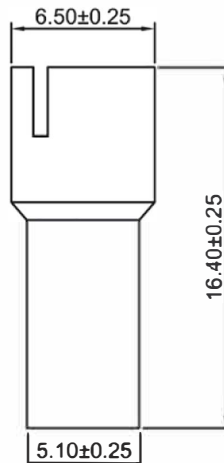
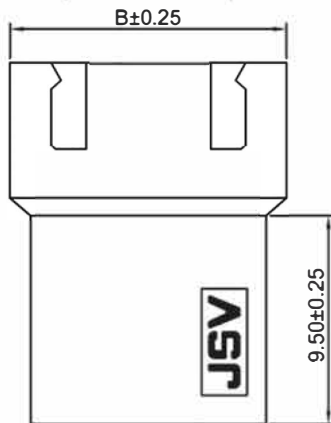
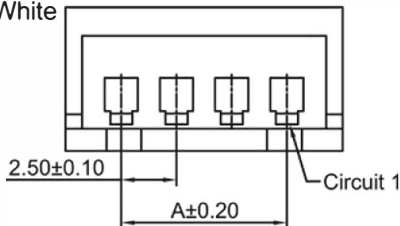

A2501 SERIES 2.50mm pitch wire to board and wire to wire connector

A2501WV

2.50mm pitch 180° Wafer

Reference Informations:

- *Material: Pin: Brass/Tin over Nickel
Insulator: Nylon 66, UL94V-0
- *Mates with A2501 H series Housing *Color: White

Ordering Information:
A2501WV- * -NP- **
1 2 3

1. Part No
2. Style:
(blank) : Type 1
2 : Type 2
3. Color:
(blank) : White
YL: Yellow
BK: Black
BL: Blue
RD: Red
GN: Green

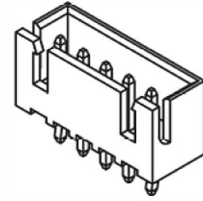

Ordering Information & Dimensions

PART NO.	Dimensions	
	A	B
A2501WV-02P	2.50	7.50
A2501WV-03P	5.00	10.00
A2501WV-04P	7.50	12.50
A2501WV-05P	10.00	15.00
A2501WV-06P	12.50	17.50
A2501WV-07P	15.00	20.00
A2501WV-08P	17.50	22.50
A2501WV-09P	20.00	25.00
A2501WV-10P	22.50	27.50
A2501WV-11P	25.00	30.00
A2501WV-12P	27.50	32.50
A2501WV-13P	30.00	35.00
A2501WV-14P	32.50	37.50
A2501WV-15P	35.00	40.00
A2501WV-16P	37.50	42.50
A2501WV-17P	40.00	45.00
A2501WV-18P	42.50	47.50
A2501WV-19P	45.00	50.00
A2501WV-20P	47.50	52.50

Unit: mm

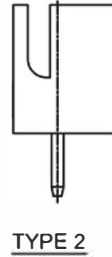
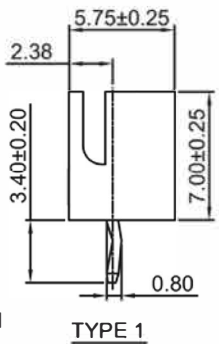
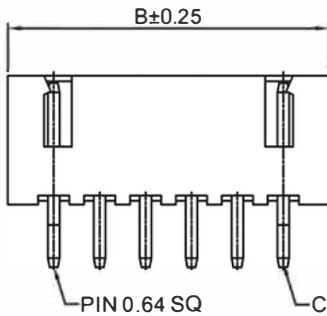
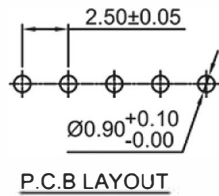
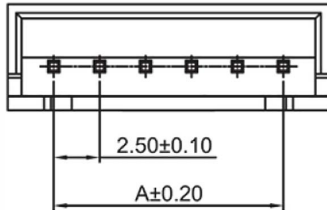

A2501WV-F

2.50mm pitch 180° Wafer - With Boss

Reference Informations:

- *Material: Pin: Brass/Tin over Nickel
Insulator: Nylon 66, UL94V-0
- *Color: White
- *Mates with A2501H series Housing *

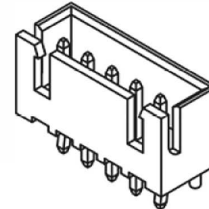

Ordering Information & Dimensions:

PART NO.	Dimensions	
	A	B
A2501WV-F-02P	2.50	7.50
A2501WV-F-03P	5.00	10.00
A2501WV-F-04P	7.50	12.50
A2501WV-F-05P	10.00	15.00
A2501WV-F-06P	12.50	17.50
A2501WV-F-07P	15.00	20.00
A2501WV-F-08P	17.50	22.50
A2501WV-F-09P	20.00	25.00
A2501WV-F-10P	22.50	27.50
A2501WV-F-11P	25.00	30.00
A2501WV-F-12P	27.50	32.50
A2501WV-F-13P	30.00	35.00
A2501WV-F-14P	32.50	37.50
A2501WV-F-15P	35.00	40.00
A2501WV-F-16P	37.50	42.50
A2501WV-F-17P	40.00	45.00
A2501WV-F-18P	42.50	47.50
A2501WV-F-19P	45.00	50.00
A2501WV-F-20P	47.50	52.50

Unit: mm

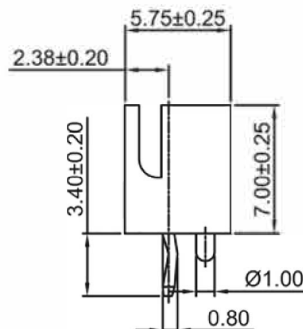
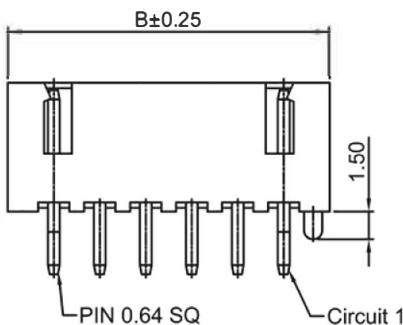
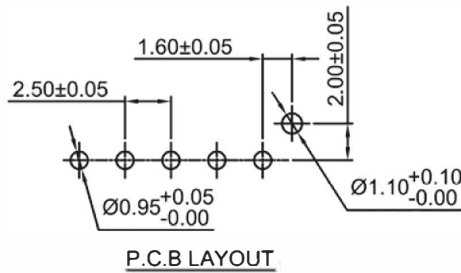
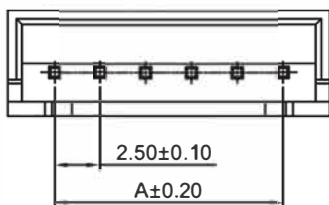

A2501 SERIES 2.50mm pitch wire to board and wire to wire connector

A2501WR

2.50mm pitch 180° Wafer

Reference Informations:

- *Material: Pin: Brass/Tin over Nickel
Insulator: Nylon 66, UL94V-0
- *Mates with A2501 H series Housing *Color: White

Ordering Information:
A2501WR - ** -NP **
1 2 3

1. Part No
2. Style:
(blank) : Type 1
2 : Type 2
3. Color:
(blank): White
YL: Yellow
BK: Black
BL: Blue
RD: Red
GN: Green

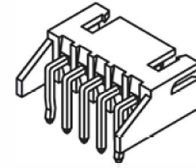

Ordering Information & Dimensions:

PART NO.	Dimensions	
	A	B
A2501WR-02P	2.50	7.50
A2501WR-03P	5.00	10.00
A2501WR-04P	7.50	12.50
A2501WR-05P	10.00	15.00
A2501WR-06P	12.50	17.50
A2501WR-07P	15.00	20.00
A2501WR-08P	17.50	22.50
A2501WR-09P	20.00	25.00
A2501WR-10P	22.50	27.50
A2501WR-11P	25.00	30.00
A2501WR-12P	27.50	32.50
A2501WR-13P	30.00	35.00
A2501WR-14P	32.50	37.50
A2501WR-15P	35.00	40.00
A2501WR-16P	37.50	42.50
A2501WR-17P	40.00	45.00
A2501WR-18P	42.50	47.50
A2501WR-19P	45.00	50.00
A2501WR-20P	47.50	52.50

Unit: mm

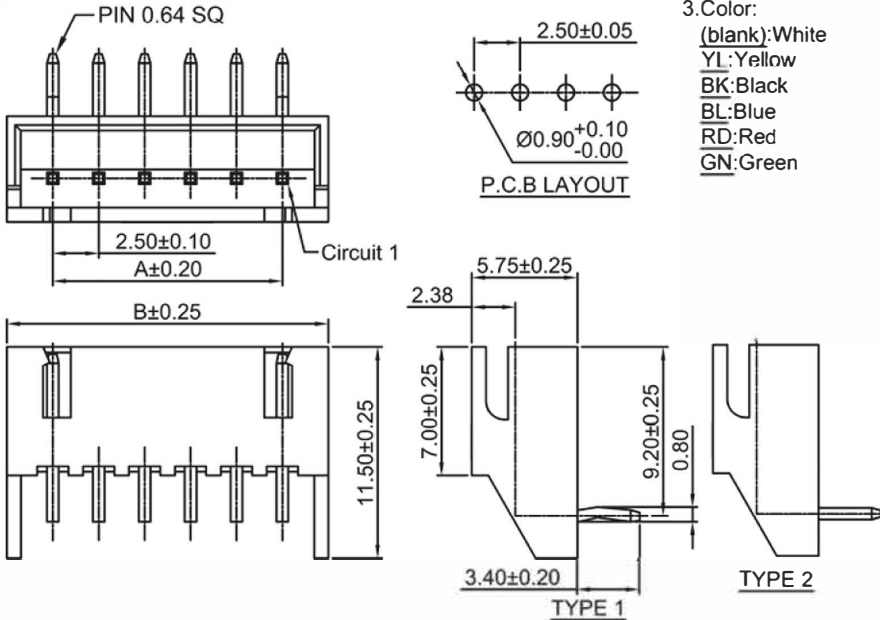

A2501WRB

2.50mm pitch 180° Wafer

Reference Informations:

- *Material: Pin: Brass/Tin over Nickel
Insulator: Nylon 66, UL94V-0
- *Color: White
- *Mates with A2501H series Housing *

Ordering Information:
A2501WRB - ** -NP- **
1 2 3

1. Part No
2. Style:
(blank) : Type 1
2 : Type 2
3. Color:
(blank): White
YL: Yellow
BK: Black
BL: Blue
RD: Red
GN: Green

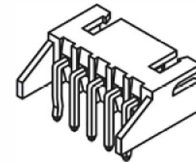

Ordering Information & Dimensions:

PART NO.	Dimensions	
	A	B
A2501WRB-02P	2.50	7.50
A2501WRB-03P	5.00	10.00
A2501WRB-04P	7.50	12.50
A2501WRB-05P	10.00	15.00
A2501WRB-06P	12.50	17.50
A2501WRB-07P	15.00	20.00
A2501WRB-08P	17.50	22.50
A2501WRB-09P	20.00	25.00
A2501WRB-10P	22.50	27.50
A2501WRB-11P	25.00	30.00
A2501WRB-12P	27.50	32.50
A2501WRB-13P	30.00	35.00
A2501WRB-14P	32.50	37.50
A2501WRB-15P	35.00	40.00
A2501WRB-16P	37.50	42.50
A2501WRB-17P	40.00	45.00
A2501WRB-18P	42.50	47.50
A2501WRB-19P	45.00	50.00
A2501WRB-20P	47.50	52.50

Unit: mm

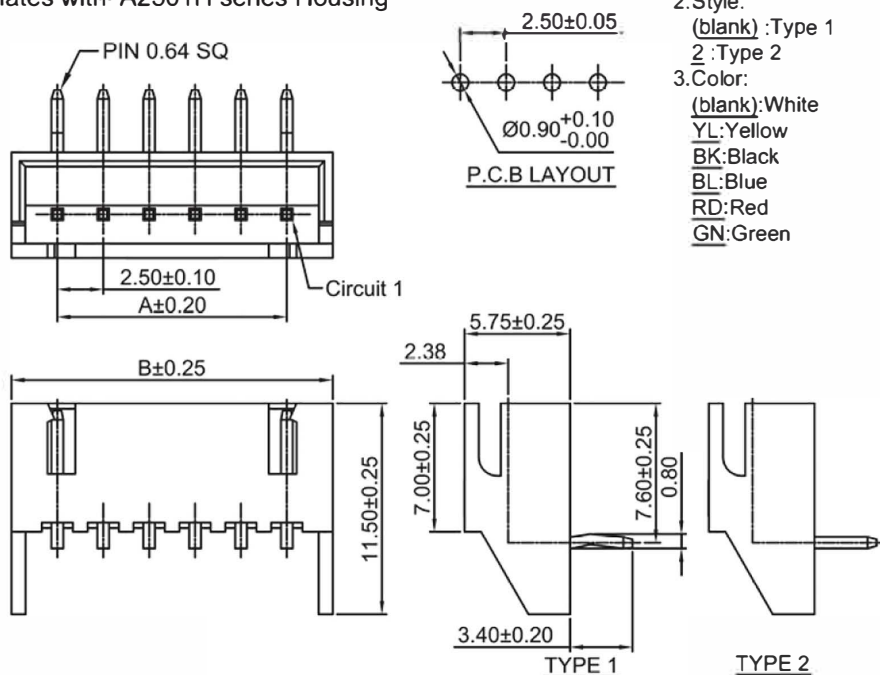

A2501 SERIES 2.50mm pitch wire to board and wire to wire connector

A2501WVR

2.50mm pitch 90° Wafer

Reference Informations:

- *Material:Pin:Brass/Tin over Nickel
Insulator:Nylon 66,UL94V-0
- *Mates with A2501H series Housing *Color:White

Ordering Information:

- A2501WVR - ** - NP
1 2
- 1.Part No
 - 2.Style:
(blank) :Type 1
2 :Type 2

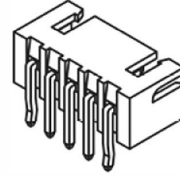

Ordering Information & Dimensions:

PART NO.	Dimensions	
	A	B
A2501WVR-02P	2.50	7.50
A2501WVR-03P	5.00	10.00
A2501WVR-04P	7.50	12.50
A2501WVR-05P	10.00	15.00
A2501WVR-06P	12.50	17.50
A2501WVR-07P	15.00	20.00
A2501WVR-08P	17.50	22.50
A2501WVR-09P	20.00	25.00
A2501WVR-10P	22.50	27.50
A2501WVR-11P	25.00	30.00
A2501WVR-12P	27.50	32.50
A2501WVR-13P	30.00	35.00
A2501WVR-14P	32.50	37.50
A2501WVR-15P	35.00	40.00
A2501WVR-16P	37.50	42.50
A2501WVR-17P	40.00	45.00
A2501WVR-18P	42.50	47.50
A2501WVR-19P	45.00	50.00
A2501WVR-20P	47.50	52.50

Unit: mm

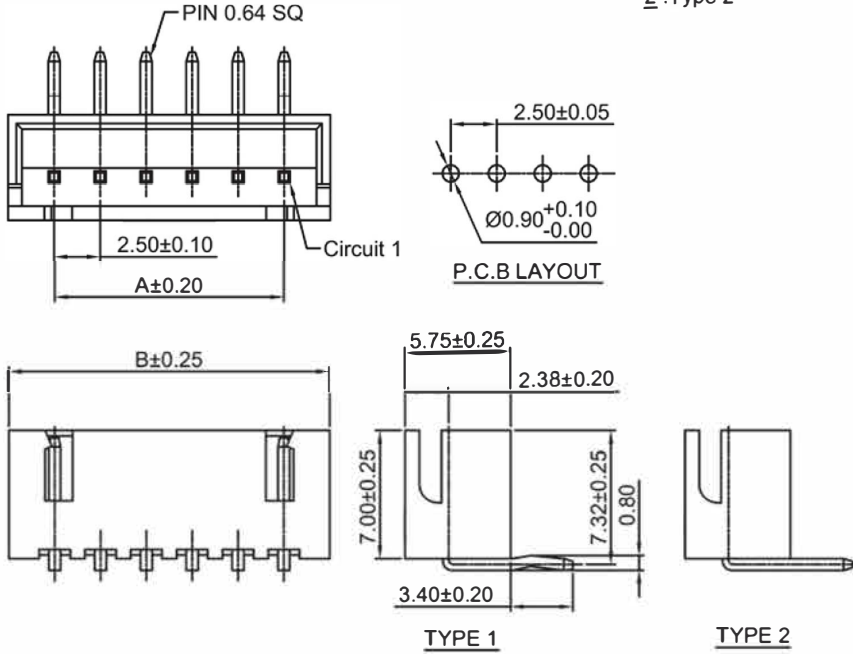

A2501WV-S

2.50mm pitch 180° Wafer - SMT TYPE

Reference Informations:

- *Material:Pin:Brass/Tin over Nickel
Solder Tabs:Phosphor Bronze/Tin over Nickel
Insulator:LCP,UL94V-0
- *Mates with A2501H series Housing
- *Color:White

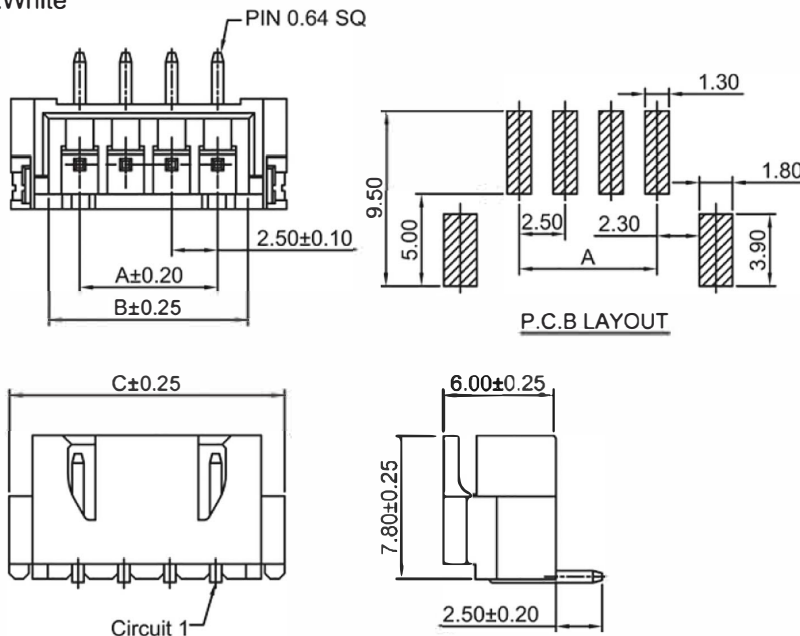

Ordering Information & Dimensions:

PART NO.	Dimensions		
	A	B	C
A2501WV-S-02P	2.50	5.90	10.00
A2501WV-S-03P	5.00	8.40	12.50
A2501WV-S-04P	7.50	10.90	15.00
A2501WV-S-05P	10.00	13.40	17.50
A2501WV-S-06P	12.50	15.90	20.00
A2501WV-S-07P	15.00	18.40	22.50
A2501WV-S-08P	17.50	20.90	25.00
A2501WV-S-09P	20.00	23.40	27.50
A2501WV-S-10P	22.50	25.90	30.00
A2501WV-S-11P	25.00	28.40	32.50
A2501WV-S-12P	27.50	30.90	35.00
A2501WV-S-13P	30.00	33.40	37.50
A2501WV-S-14P	32.50	35.90	40.00
A2501WV-S-15P	35.00	38.40	42.50
A2501WV-S-16P	37.50	40.90	45.00

Unit: mm

A2501 SERIES 2.50mm pitch wire to board and wire to wire connector

A2501WR-S

2.50mm pitch 90° Wafer - SMT TYPE

Reference Informations:

- *Material: Pin: Brass/Tin over Nickel
Insulator: Nylon 6T, UL94V-0
- *Mates with A2501H series Housing
- *Color: White

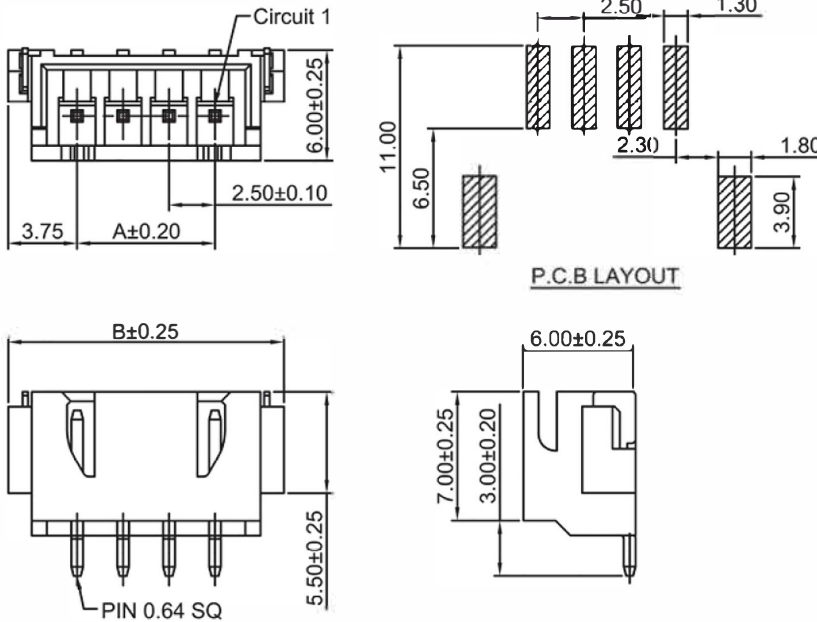
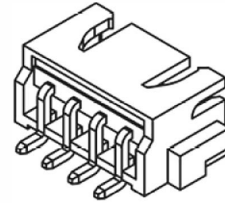

Ordering Information & Dimensions:

PART NO.	Dimensions	
	A	B
A2501WR-S-02P	2.50	10.00
A2501WR-S-03P	5.00	12.50
A2501WR-S-04P	7.50	15.00
A2501WR-S-05P	10.00	17.50
A2501WR-S-06P	12.50	20.00
A2501WR-S-07P	15.00	22.50
A2501WR-S-08P	17.50	25.00
A2501WR-S-09P	20.00	27.50
A2501WR-S-10P	22.50	30.00
A2501WR-S-11P	25.00	32.50
A2501WR-S-12P	27.50	35.00
A2501WR-S-13P	30.00	37.50
A2501WR-S-14P	32.50	40.00
A2501WR-S-15P	35.00	42.50
A2501WR-S-16P	37.50	45.00
A2501WR-S-17P	40.00	47.50
A2501WR-S-18P	42.50	50.00
A2501WR-S-19P	45.00	52.50
A2501WR-S-20P	47.50	55.00

Unit: mm

A2501WRA-S-F-02P

2.50mm pitch 90° Wafer - SMT TYPE

Reference Informations:

- *Material: Pin: Copper Alloy/Tin Over Nickel
Insulator: Nylon 9T, UL94V-0
- *Color: Ivory

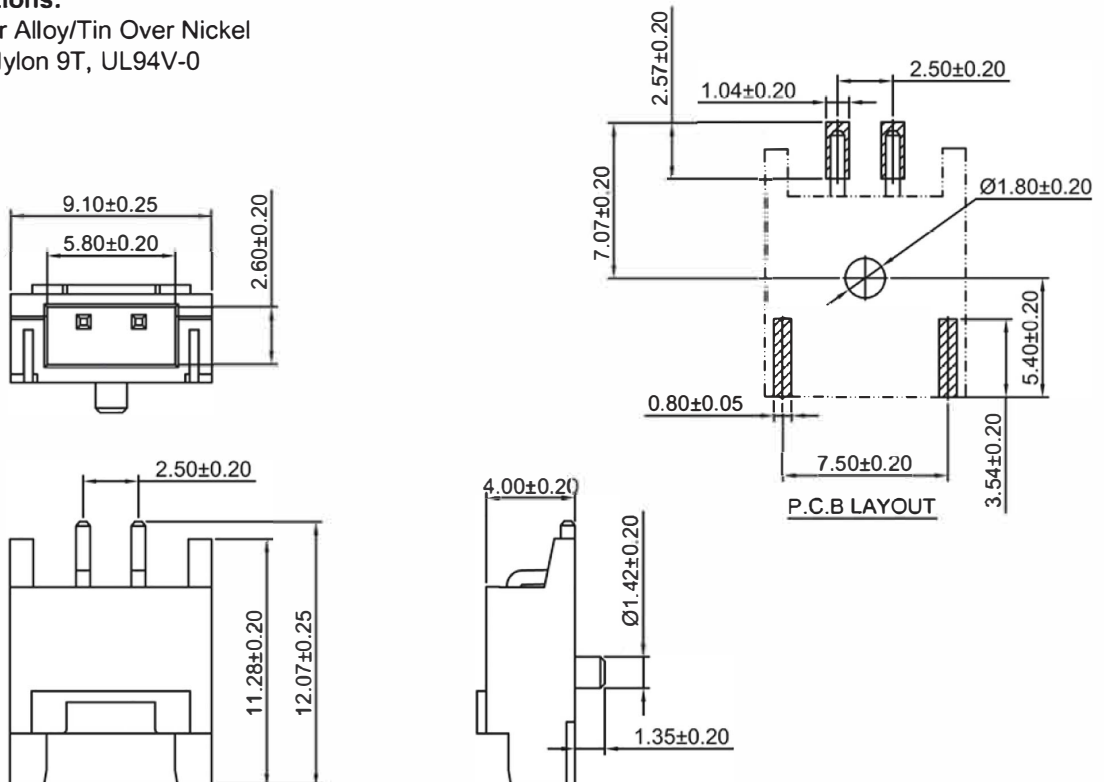

A2501 SERIES 2.50mm pitch wire to board and wire to wire connector

A2501WVC

2.50mm pitch 180° Wafer

Reference Informations:

- *Material:Pin:Brass/Tin over Nickel
Insulator:Nylon 66,UL94V-0
- *Mates with A2501H series Housing
- *Color:Natural

Ordering Information:

A2501WVC-NP-□-□-□
1 2 3

- 1.Material:
0=Nylon 66,UL94V-0
- 2.Color code:
NA:Natural
- 3.Client code

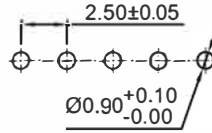
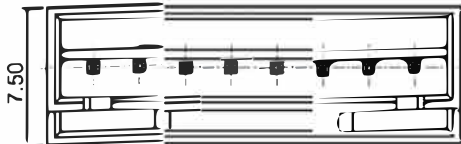
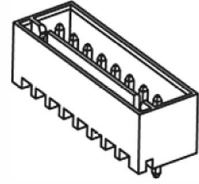

P.C.B LAYOUT

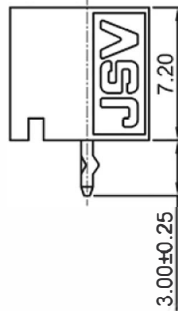
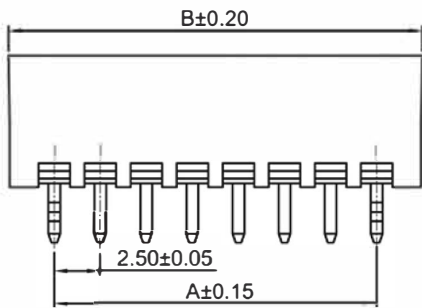

Ordering Information & Dimensions

PART NO.	Dimensions	
	A	B
A2501WVC-02P	2.50	7.50
A2501WVC-03P	5.00	10.00
A2501WVC-04P	7.50	12.50
A2501WVC-05P	10.00	15.00
A2501WVC-06P	12.50	17.50
A2501WVC-07P	15.00	20.00
A2501WVC-08P	17.50	22.50
A2501WVC-09P	20.00	25.00
A2501WVC-10P	22.50	27.50
A2501WVC-11P	25.00	30.00
A2501WVC-12P	27.50	32.50
A2501WVC-13P	30.00	35.00
A2501WVC-14P	32.50	37.50
A2501WVC-15P	35.00	40.00
A2501WVC-16P	37.50	42.50
A2501WVC-17P	40.00	45.00
A2501WVC-18P	42.50	47.50
A2501WVC-19P	45.00	50.00
A2501WVC-20P	47.50	52.50

Unit: mm