

A2502 SERIES

2.50mm pitch wire to board connector

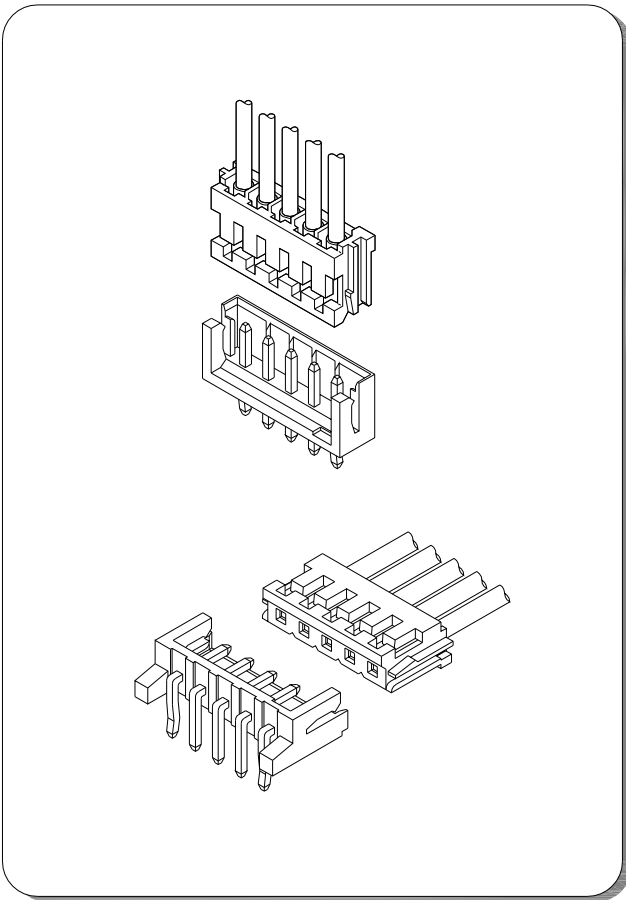

Specifications

- Current rating:3A AC,DC
- Voltage rating:250V AC,DC
- Temperature range:-40°C~+105°C
- Contact resistance:10mΩMax.
- Insulation resistance:1000MΩMin.
- Withstanding voltage:800V AC/minute
- *Compliant with RoHS and REACH*
- *Meet the HF/Halogen Free,need to customize*
- *Contact for details*

Standards



Assembly layout

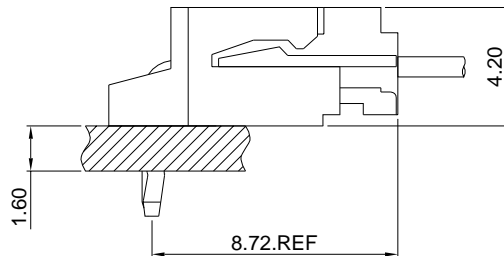
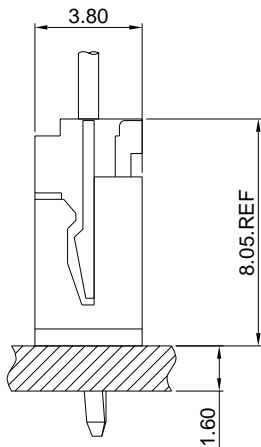

A2502 SERIES

2.50mm pitch wire to board connector

A2502-T

2.50mm pitch Crimp Terminal

Reference Informations:

*Used in A2502 series Housing

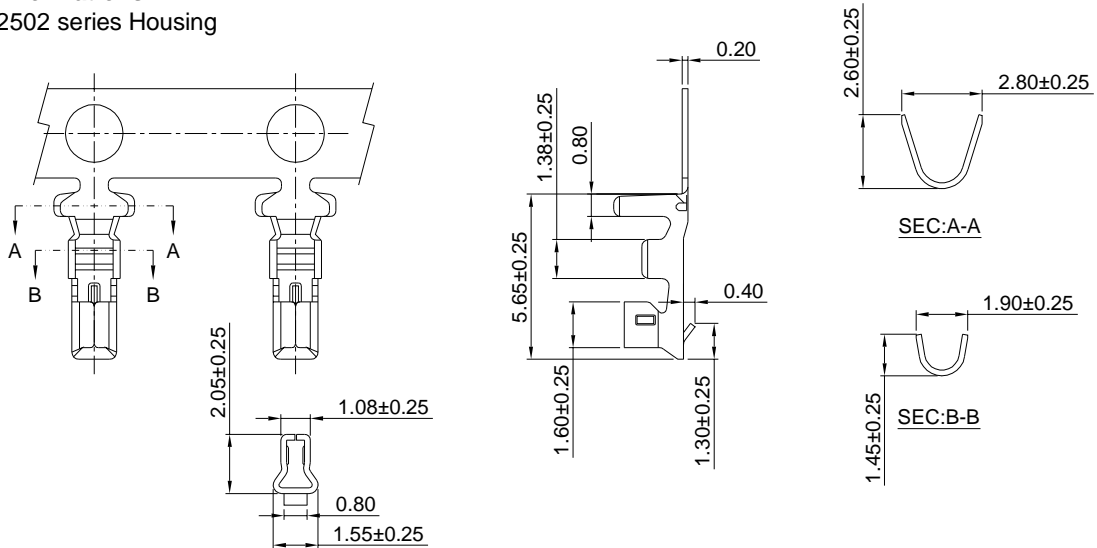

Ordering information & Specifications

Unit:mm

Part NO	Wire Range	Insulation O.D.	Material	Finish	Qty/reel
A2502-TP	AWG#22-#30	1.90mm(max)	Phosphor Bronze	Tin over Nickel	10,000 PCS
A2502-GP	AWG#22-#30	1.90mm(max)	Phosphor Bronze	Gold over Nickel	10,000 PCS

Optional Gold plating available but MOQ requested

A2502H

2.50mm pitch Housing

Reference Informations:

*Material:Nylon 66,UL94V-0

*Suitable A2502 series Terminal

*Mates with A2502 series Wafer

*Color:White

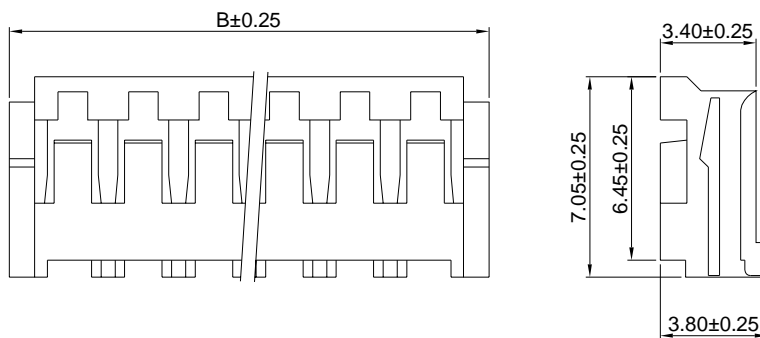
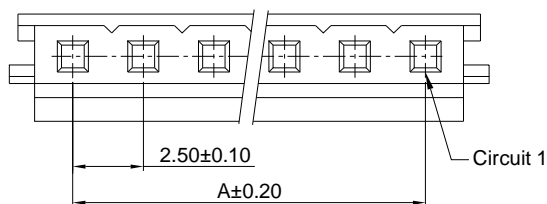
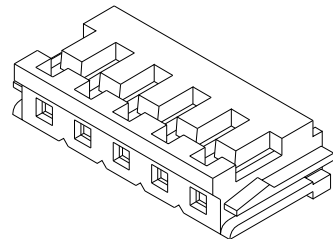

Ordering Information & Dimensions

PART NO.	Dimensions	
	A	B
A2502H-2P	2.50	7.00
A2502H-3P	5.00	9.50
A2502H-4P	7.50	12.00
A2502H-5P	10.00	14.50
A2502H-6P	12.50	17.00
A2502H-7P	15.00	19.50
A2502H-8P	17.50	22.00
A2502H-9P	20.00	24.50
A2502H-10P	22.50	27.00
A2502H-11P	25.00	29.50
A2502H-12P	27.50	32.00
A2502H-13P	30.00	34.50
A2502H-14P	32.50	37.00
A2502H-15P	35.00	39.50

Unit: mm

A2502 SERIES

2.50mm pitch wire to board connector

A2502WV

2.50mm pitch 180° Wafer

Reference Informations:

- *Material:Pin:Brass/Tin over Nickel
Insulator:Nylon 66,UL94V-0
- *Mates with A2502 series Housing
- *Color:White

Ordering Information:

- A2502WV-XP - **
1 2
- 1.Part No.
 - 2.Style
(blank)-Type 1
2-Type 2

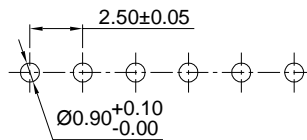
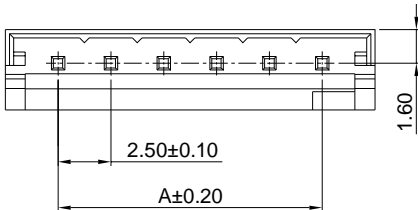

P.C.B LAYOUT

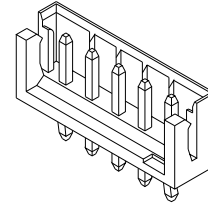

Ordering Information & Dimensions

PART NO.	Dimensions	
	A	B
A2502WV-2P	2.50	7.50
A2502WV-3P	5.00	10.00
A2502WV-4P	7.50	12.50
A2502WV-5P	10.00	15.00
A2502WV-6P	12.50	17.50
A2502WV-7P	15.00	20.00
A2502WV-8P	17.50	22.50
A2502WV-9P	20.00	25.00
A2502WV-10P	22.50	27.50
A2502WV-11P	25.00	30.00
A2502WV-12P	27.50	32.50
A2502WV-13P	30.00	35.00
A2502WV-14P	32.50	37.50
A2502WV-15P	35.00	40.00

Unit: mm

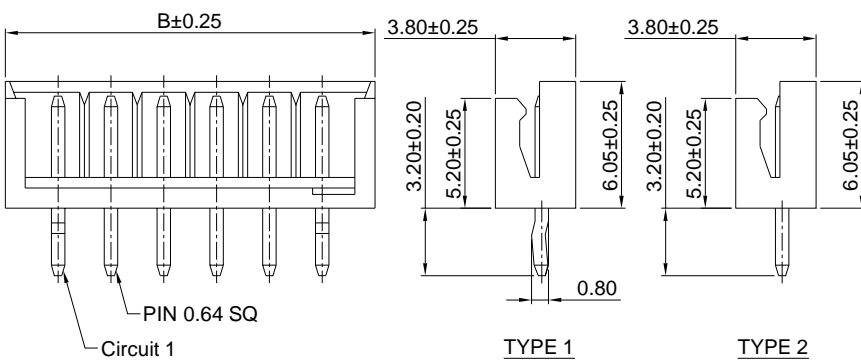

A2502WR

2.50mm pitch 90° Wafer

Reference Informations:

- *Material:Pin:Brass/Tin over Nickel
Insulator:Nylon 66,UL94V-0
- *Mates with A2502 series Housing
- *Color:White

Ordering Information:

- A2502WR-XP - **
1 2
- 1.Part No.
 - 2.Style
(blank)-Type 1
2-Type 2

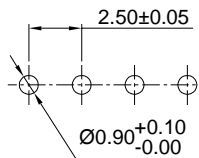
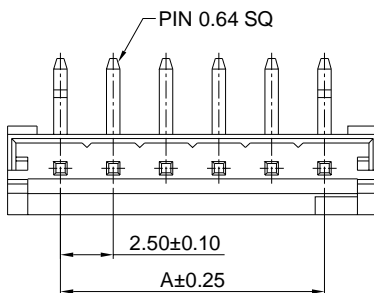

P.C.B LAYOUT

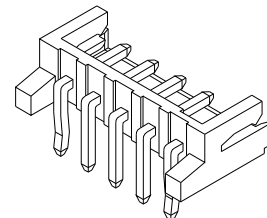

Ordering Information & Dimensions

PART NO.	Dimensions	
	A	B
A2502WR-2P	2.50	7.50
A2502WR-3P	5.00	10.00
A2502WR-4P	7.50	12.50
A2502WR-5P	10.00	15.00
A2502WR-6P	12.50	17.50
A2502WR-7P	15.00	20.00
A2502WR-8P	17.50	22.50
A2502WR-9P	20.00	25.00
A2502WR-10P	22.50	27.50
A2502WR-11P	25.00	30.00
A2502WR-12P	27.50	32.50
A2502WR-13P	30.00	35.00
A2502WR-14P	32.50	37.50
A2502WR-15P	35.00	40.00

Unit: mm

