

A2543 SERIES

2.54mm pitch wire to board connector

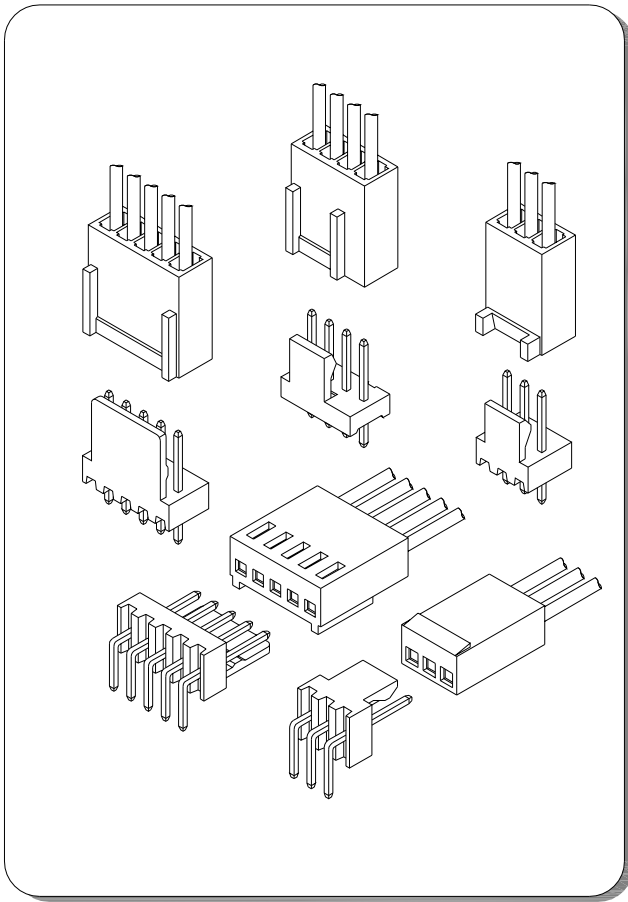

Specifications

- Current rating: 4A AC, DC
- Voltage rating: 250V AC, DC
- Temperature range: -40°C ~ +105°C
- Contact resistance: 10mΩ Max.
- Insulation resistance: 1000MΩ Min.
- Withstanding voltage: 1000V AC/minute
- *Compliant with RoHS and REACH*
- *Meet the HF/Halogen Free, need to customize*
- *Contact for details*

Standards



Assembly layout

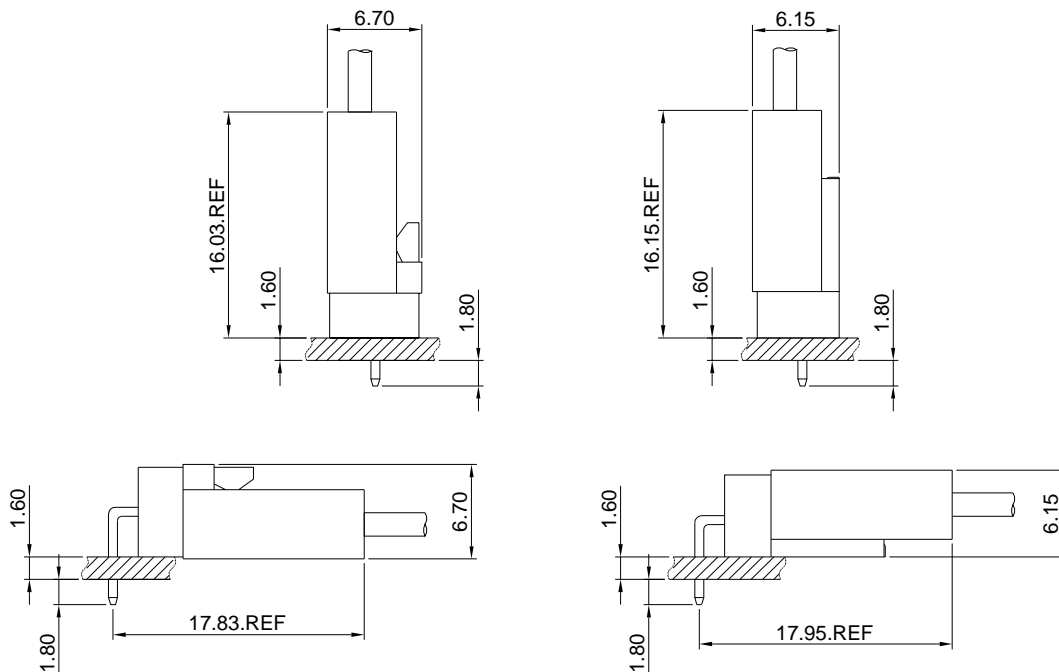

A2543 SERIES

2.54mm pitch wire to board connector

A2543-T

2.54mm Pitch Crimp Terminal

Reference Informations:

*Used in A2543 series Housing

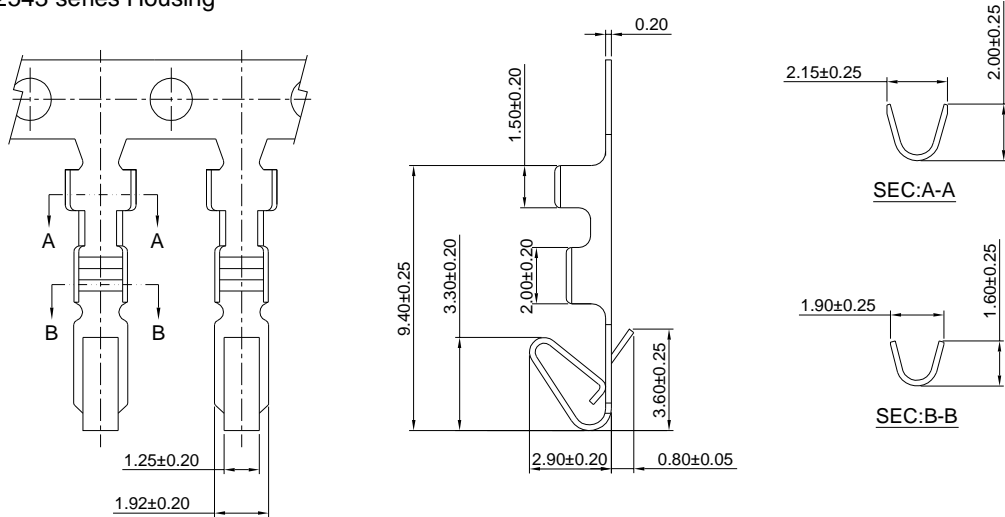

Ordering information & Specifications:

Unit:mm

Part NO.	Wire Range	Insulation O.D.	Material	Finish	Qty/reel
A2543-TB	AWG#22-#28	1.90mm(max)	Brass	Tin over Nickel	10,000 PCS
A2543-TP	AWG#22-#28	1.90mm(max)	Phosphor Bronze	Tin over Nickel	10,000 PCS
A2543-GB	AWG#22-#28	1.90mm(max)	Brass	Gold over Nickel	10,000 PCS
A2543-GP	AWG#22-#28	1.90mm(max)	Phosphor Bronze	Gold over Nickel	10,000 PCS

Optional Gold plating available but MOQ requested

A2543H

2.54mm Pitch Housing

Reference Informations:

*Material:Nylon 66 ,UL94V-0

*Suitable A2543 series Terminal

*Mates with A2543 series Wafer

*Color:Beige or White

Ordering Information:

A2543H-XP - **
1 2

1.Part No.

2.Style:

(blank) :Type 1/Beige

2 :Type 2/White

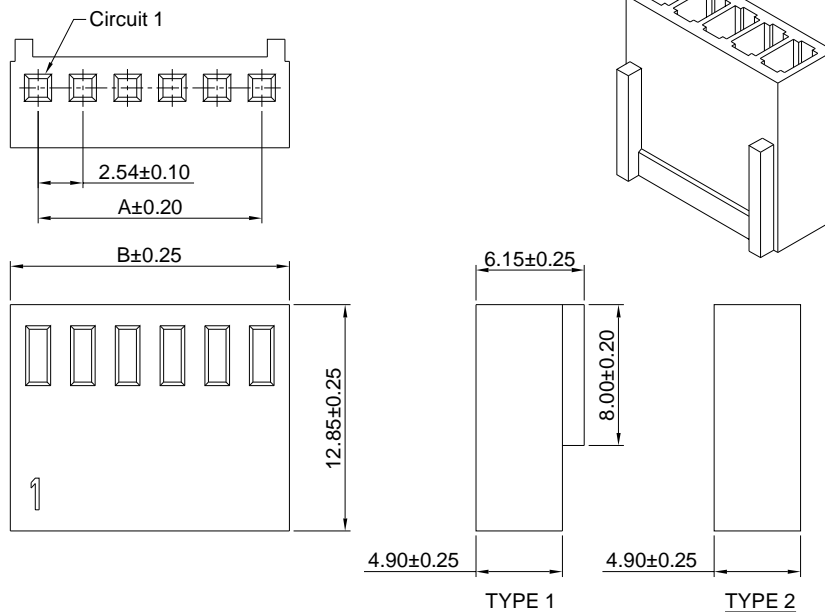

Ordering Information & Dimensions:

PART NO.	Dimensions	
	A	B
A2543H-2P	2.54	5.68
A2543H-3P	5.08	8.22
A2543H-4P	7.62	10.76
A2543H-5P	10.16	13.30
A2543H-6P	12.70	15.84
A2543H-7P	15.24	18.38
A2543H-8P	17.78	20.92
A2543H-9P	20.32	23.46
A2543H-10P	22.86	26.00
A2543H-11P	25.40	28.54
A2543H-12P	27.94	31.08
A2543H-13P	30.48	33.62
A2543H-14P	32.02	36.16
A2543H-15P	35.56	38.70
A2543H-16P	38.10	41.24
A2543H-17P	40.64	43.78
A2543H-18P	43.18	46.32
A2543H-19P	45.72	48.86
A2543H-20P	48.26	51.40
A2543H-21P	50.80	53.94
A2543H-22P	53.34	56.48
A2543H-23P	55.88	59.02
A2543H-24P	58.42	61.56
A2543H-25P	60.96	64.10

Unit: mm

A2543 SERIES

2.54mm pitch wire to board connector

A2543HA

2.54mm Pitch Housing

Reference Informations:

- *Material:Nylon 66 ,UL94V-0
- *Suitable A2543 series Terminal
- *Mates with A2543 series Wafer
- *Color: Brown

Ordering Information:

A2543HA - $\frac{**}{1 \quad 2}$

- 1.Part No.
- 2.Color:
(blank):Brown
WH:White

Ordering Information & Dimensions:

PART NO.	Dimensions	
	A	B
A2543HA-2P	2.54	5.68
A2543HA-3P	5.08	8.22
A2543HA-4P	7.62	10.76
A2543HA-5P	10.16	13.30
A2543HA-6P	12.70	15.84
A2543HA-7P	15.24	18.38
A2543HA-8P	17.78	20.92
A2543HA-9P	20.32	23.46
A2543HA-10P	22.86	26.00
A2543HA-11P	25.40	28.54
A2543HA-12P	27.94	31.08
A2543HA-13P	30.48	33.62
A2543HA-14P	32.02	36.16
A2543HA-15P	35.56	38.70
A2543HA-16P	38.10	41.24
A2543HA-17P	40.64	43.78
A2543HA-18P	43.18	46.32
A2543HA-19P	45.72	48.86
A2543HA-20P	48.26	51.40
A2543HA-21P	50.80	53.94
A2543HA-22P	53.34	56.48
A2543HA-23P	55.88	59.02
A2543HA-24P	58.42	61.56
A2543HA-25P	60.96	64.10

Unit: mm

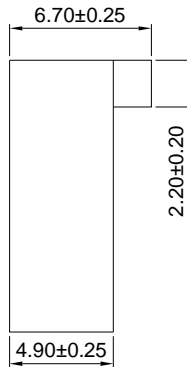
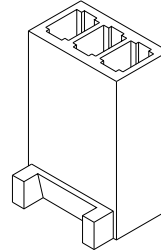
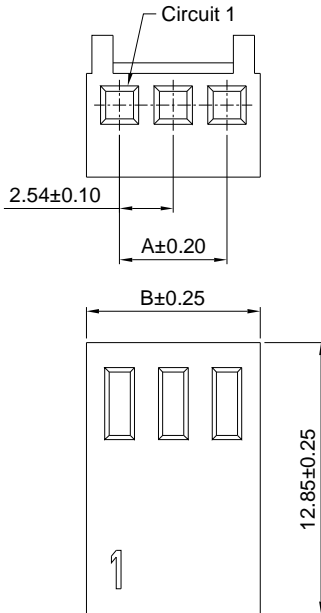

A2543HB

2.54mm Pitch Housing

Reference Informations:

- *Material:Nylon 66 ,UL94V-0
- *Suitable A2543 series Terminal
- *Mates with A2543 series Wafer
- *Color:Brown

Ordering Information:

A2543HB - $\frac{**}{1 \quad 2}$

- 1.Part No.
- 2.Color:
(blank):Brown
WH:White

Ordering Information & Dimensions:

PART NO.	Dimensions	
	A	B
A2543HB-2P	2.54	5.68
A2543HB-3P	5.08	8.22
A2543HB-4P	7.62	10.76
A2543HB-5P	10.16	13.30
A2543HB-6P	12.70	15.84
A2543HB-7P	15.24	18.38
A2543HB-8P	17.78	20.92
A2543HB-9P	20.32	23.46
A2543HB-10P	22.86	26.00
A2543HB-11P	25.40	28.54
A2543HB-12P	27.94	31.08
A2543HB-13P	30.48	33.62
A2543HB-14P	32.02	36.16
A2543HB-15P	35.56	38.70
A2543HB-16P	38.10	41.24
A2543HB-17P	40.64	43.78
A2543HB-18P	43.18	46.32
A2543HB-19P	45.72	48.86
A2543HB-20P	48.26	51.40
A2543HB-21P	50.80	53.94
A2543HB-22P	53.34	56.48
A2543HB-23P	55.88	59.02
A2543HB-24P	58.42	61.56
A2543HB-25P	60.96	64.10

Unit: mm

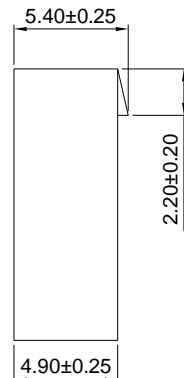
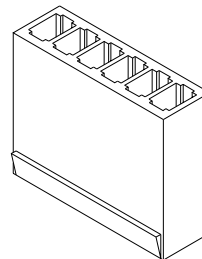
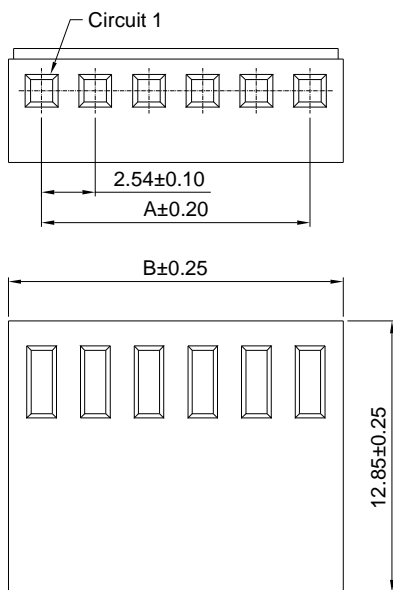

A2543 SERIES

2.54mm pitch wire to board connector

A2543HC-4P

2.54mm Pitch Housing

Reference Informations:

- *Material:Nylon 66 ,UL94V-0
- *Suitable A2543 series Terminal
- *Mates with A2543WVC series Wafer
- *Color:Beige

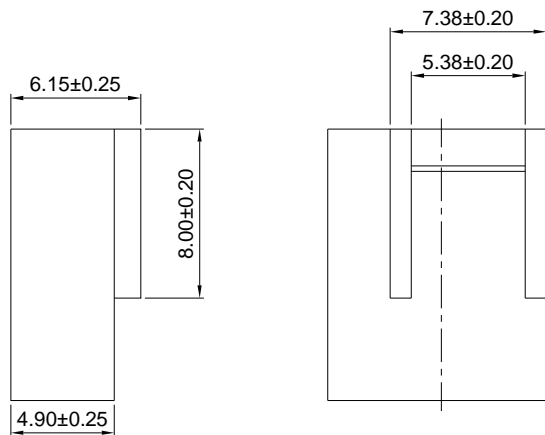
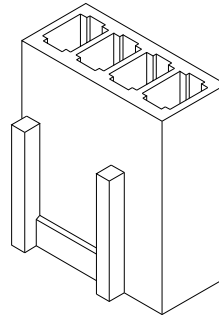
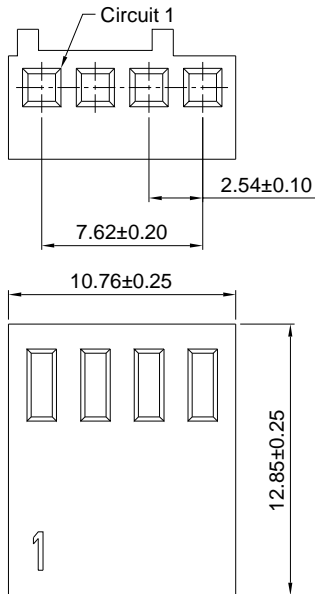

Unit: mm

A2543WV

2.54mm pitch 180° Wafer

Reference Informations:

- *Material:Pin:Brass/Tin over Nickel
Insulator:Nylon 66 ,UL94V-0
- *Mates with A2543 series Housing
- *Color:Beige

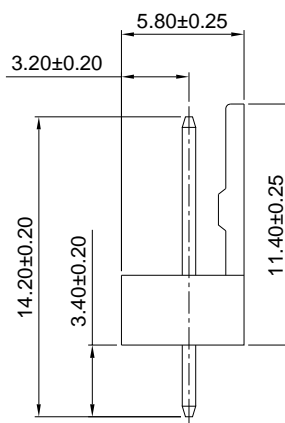
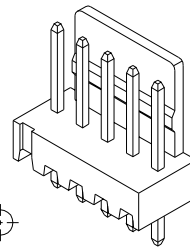
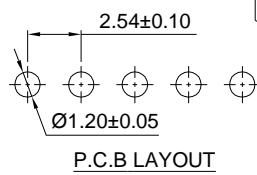
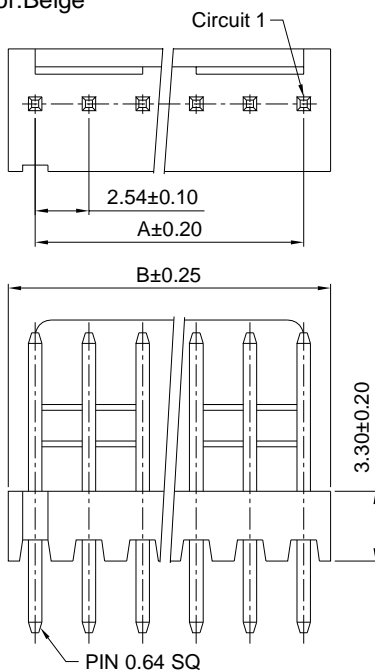

Ordering Information & Dimensions:

PART NO.	Dimensions	
	A	B
A2543WV-2P	2.54	5.08
A2543WV-3P	5.08	7.62
A2543WV-4P	7.62	10.16
A2543WV-5P	10.16	12.70
A2543WV-6P	12.70	15.24
A2543WV-7P	15.24	17.78
A2543WV-8P	17.78	20.32
A2543WV-9P	20.32	22.86
A2543WV-10P	22.86	25.40
A2543WV-11P	25.40	27.94
A2543WV-12P	27.94	30.48
A2543WV-13P	30.48	32.02
A2543WV-14P	32.02	35.56
A2543WV-15P	35.56	38.10
A2543WV-16P	38.10	40.64
A2543WV-17P	40.64	43.18
A2543WV-18P	43.18	45.72
A2543WV-19P	45.72	48.26
A2543WV-20P	48.26	50.80
A2543WV-21P	50.80	53.34
A2543WV-22P	53.34	55.88
A2543WV-23P	55.88	58.42
A2543WV-24P	58.42	60.96
A2543WV-25P	60.96	63.50
A2543WV-26P	63.50	66.04
A2543WV-27P	66.04	68.58
A2543WV-28P	68.58	71.12

Unit: mm

A2543 SERIES

2.54mm pitch wire to board connector

A2543WR

2.54mm pitch 90° Wafer

Reference Informations:

- *Material:Pin:Brass/Tin over Nickel
Insulator:Nylon 66,UL94V-0
- *Mates with A2543 series Housing
- *Color:Beige

Ordering Information:

- A2543WR-XP - **
1 2
- 1.Part No.
 - 2.Style:
(blank) :Type 1
2 :Type 2

Ordering Information & Dimensions:

PART NO.	Dimensions	
	A	B
A2543WR-2P	2.54	5.08
A2543WR-3P	5.08	7.62
A2543WR-4P	7.62	10.16
A2543WR-5P	10.16	12.70
A2543WR-6P	12.70	15.24
A2543WR-7P	15.24	17.78
A2543WR-8P	17.78	20.32
A2543WR-9P	20.32	22.86
A2543WR-10P	22.86	25.40
A2543WR-11P	25.40	27.94
A2543WR-12P	27.94	30.48
A2543WR-13P	30.48	32.02
A2543WR-14P	32.02	35.56
A2543WR-15P	35.56	38.10
A2543WR-16P	38.10	40.64
A2543WR-17P	40.64	43.18
A2543WR-18P	43.18	45.72
A2543WR-19P	45.72	48.26
A2543WR-20P	48.26	50.80
A2543WR-21P	50.80	53.34
A2543WR-22P	53.34	55.88
A2543WR-23P	55.88	58.42
A2543WR-24P	58.42	60.96
A2543WR-25P	60.96	63.50
A2543WR-26P	63.50	66.04
A2543WR-27P	66.04	68.58
A2543WR-28P	68.58	71.12

Unit: mm

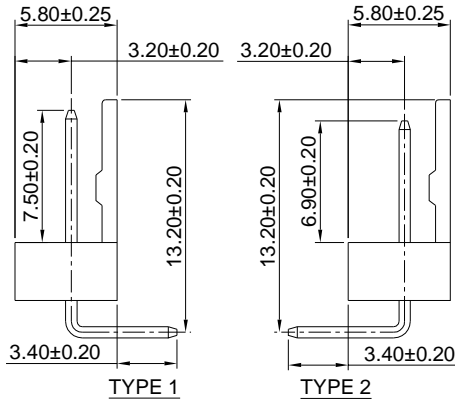
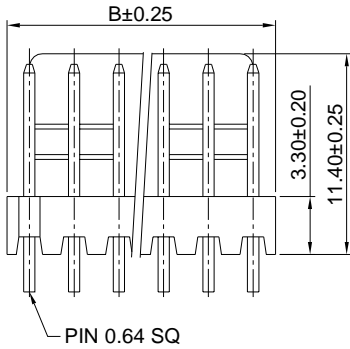
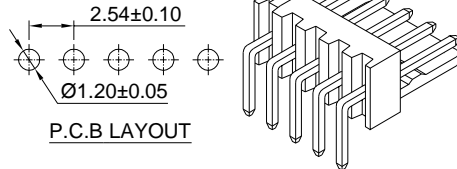
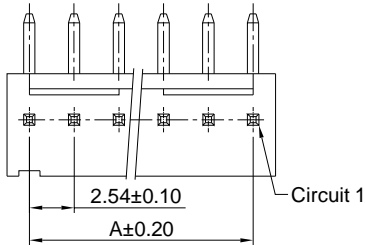

A2543WR-L

2.54mm pitch 90° Wafer

Reference Informations:

- *Material:Pin:Brass/Tin over Nickel
Insulator:Nylon 66,UL94V-0
- *Mates with A2543 series Housing
- *Color:Beige

Ordering Information:

- A2543WR-XP-L - **
1 2
- 1.Part No.
 - 2.Style:
(blank) :Type 1
2 :Type 2

Ordering Information & Dimensions:

PART NO.	Dimensions	
	A	B
A2543WR-2P-L	2.54	5.08
A2543WR-3P-L	5.08	7.62
A2543WR-4P-L	7.62	10.16
A2543WR-5P-L	10.16	12.70
A2543WR-6P-L	12.70	15.24
A2543WR-7P-L	15.24	17.78
A2543WR-8P-L	17.78	20.32
A2543WR-9P-L	20.32	22.86
A2543WR-10P-L	22.86	25.40
A2543WR-11P-L	25.40	27.94
A2543WR-12P-L	27.94	30.48
A2543WR-13P-L	30.48	32.02
A2543WR-14P-L	32.02	35.56
A2543WR-15P-L	35.56	38.10
A2543WR-16P-L	38.10	40.64
A2543WR-17P-L	40.64	43.18
A2543WR-18P-L	43.18	45.72
A2543WR-19P-L	45.72	48.26
A2543WR-20P-L	48.26	50.80
A2543WR-21P-L	50.80	53.34
A2543WR-22P-L	53.34	55.88
A2543WR-23P-L	55.88	58.42
A2543WR-24P-L	58.42	60.96
A2543WR-25P-L	60.96	63.50
A2543WR-26P-L	63.50	66.04
A2543WR-27P-L	66.04	68.58
A2543WR-28P-L	68.58	71.12

Unit: mm

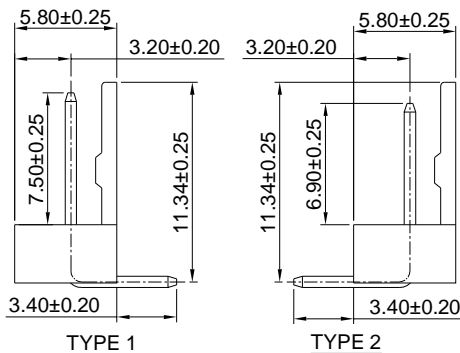
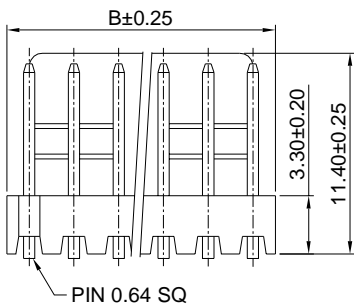
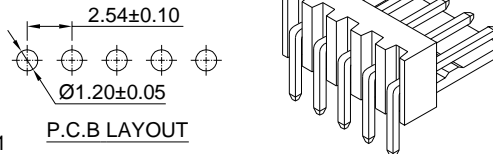
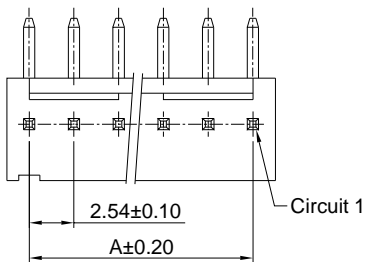

A2543 SERIES

2.54mm pitch wire to board connector

A2543WVA

2.54mm pitch 180° Wafer

Reference Informations:

- *Material:Pin:Brass/Tin over Nickel
Insulator:Nylon 66 ,UL94V-0
- *Mates with A2543 series Housing
- *Color:Brown

Ordering Information:
A2543WVA-XP - **
1 2

1.Part No.
2.Color:
(blank):Brown
WH:White

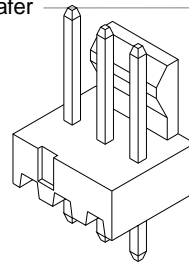

Ordering Information & Dimensions:

PART NO.	Dimensions	
	A	B
A2543WVA-2P	2.54	5.08
A2543WVA-3P	5.08	7.62
A2543WVA-4P	7.62	10.16
A2543WVA-5P	10.16	12.70
A2543WVA-6P	12.70	15.24
A2543WVA-7P	15.24	17.78
A2543WVA-8P	17.78	20.32
A2543WVA-9P	20.32	22.86
A2543WVA-10P	22.86	25.40
A2543WVA-11P	25.40	27.94
A2543WVA-12P	27.94	30.48
A2543WVA-13P	30.48	32.02
A2543WVA-14P	32.02	35.56
A2543WVA-15P	35.56	38.10
A2543WVA-16P	38.10	40.64
A2543WVA-17P	40.64	43.18
A2543WVA-18P	43.18	45.72
A2543WVA-19P	45.72	48.26
A2543WVA-20P	48.26	50.80
A2543WVA-21P	50.80	53.34
A2543WVA-22P	53.34	55.88
A2543WVA-23P	55.88	58.42
A2543WVA-24P	58.42	60.96
A2543WVA-25P	60.96	63.50
A2543WVA-26P	63.50	66.04
A2543WVA-27P	66.04	68.58
A2543WVA-28P	68.58	71.12

Unit: mm

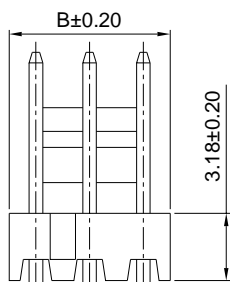
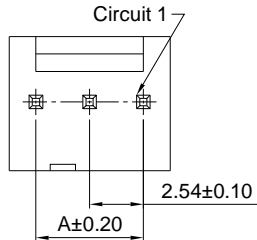

PIN 0.64 SQ

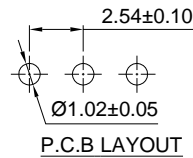
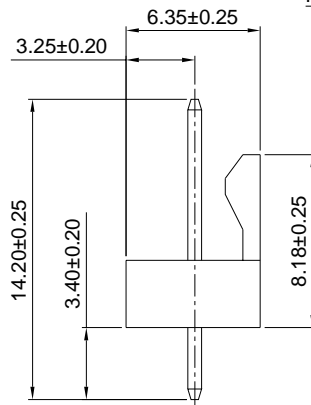

A2543WRA

2.54mm Pitch 90° Wafer

Reference Informations:

- *Material:Pin:Brass/Tin over Nickel
Insulator:PBT,UL94V-0
- *Mates with A2543 series Housing
- *Color:Brown or White

Ordering Information:
A2543WRA-XP - * - **
1 2 3

1.Part No.
2.Style:
(blank) :Type 1
2 :Type 2
3.Color:
(blank):Brown
WH:White

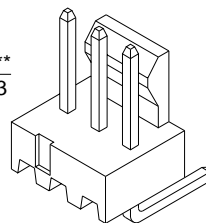

Ordering Information & Dimensions:

PART NO.	Dimensions	
	A	B
A2543WRA-2P	2.54	5.08
A2543WRA-3P	5.08	7.62
A2543WRA-4P	7.62	10.16
A2543WRA-5P	10.16	12.70
A2543WRA-6P	12.70	15.24
A2543WRA-7P	15.24	17.78
A2543WRA-8P	17.78	20.32
A2543WRA-9P	20.32	22.86
A2543WRA-10P	22.86	25.40
A2543WRA-11P	25.40	27.94
A2543WRA-12P	27.94	30.48
A2543WRA-13P	30.48	32.02
A2543WRA-14P	32.02	35.56
A2543WRA-15P	35.56	38.10
A2543WRA-16P	38.10	40.64
A2543WRA-17P	40.64	43.18
A2543WRA-18P	43.18	45.72
A2543WRA-19P	45.72	48.26
A2543WRA-20P	48.26	50.80
A2543WRA-21P	50.80	53.34
A2543WRA-22P	53.34	55.88
A2543WRA-23P	55.88	58.42
A2543WRA-24P	58.42	60.96
A2543WRA-25P	60.96	63.50
A2543WRA-26P	63.50	66.04
A2543WRA-27P	66.04	68.58
A2543WRA-28P	68.58	71.12

Unit: mm

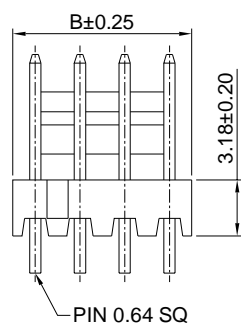
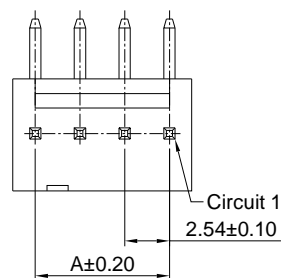

PIN 0.64 SQ

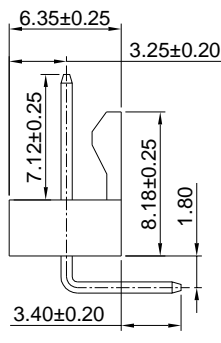

TYPE 1

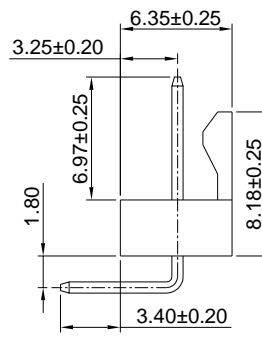

TYPE 2

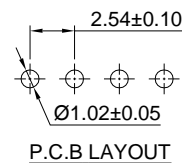

A2543 SERIES

2.54mm pitch wire to board connector

A2543WVC-4P

2.54mm pitch 180° Wafer

Reference Informations:

- *Material:Pin:Brass/Tin over Nickel
Insulator:Nylon 66 ,UL94V-0
- *Mates with A2543HC series Housing
- *Color:Beige

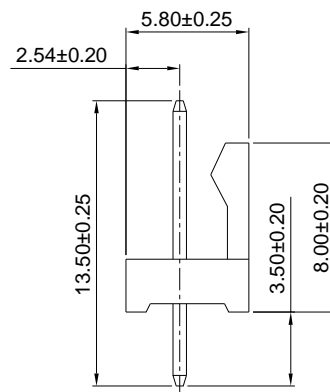
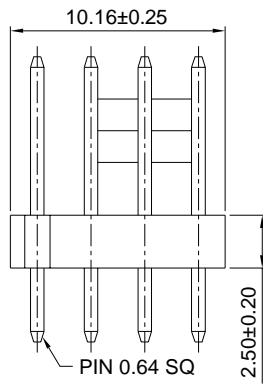
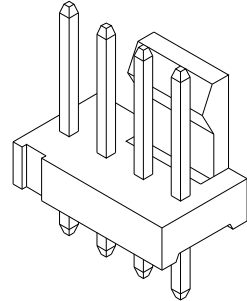
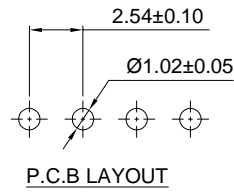
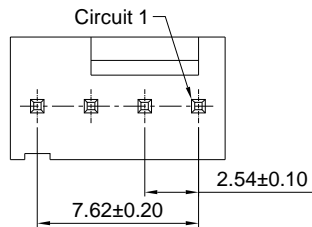

Unit: mm