

A2544 SERIES

2.50mm pitch wire to board connector

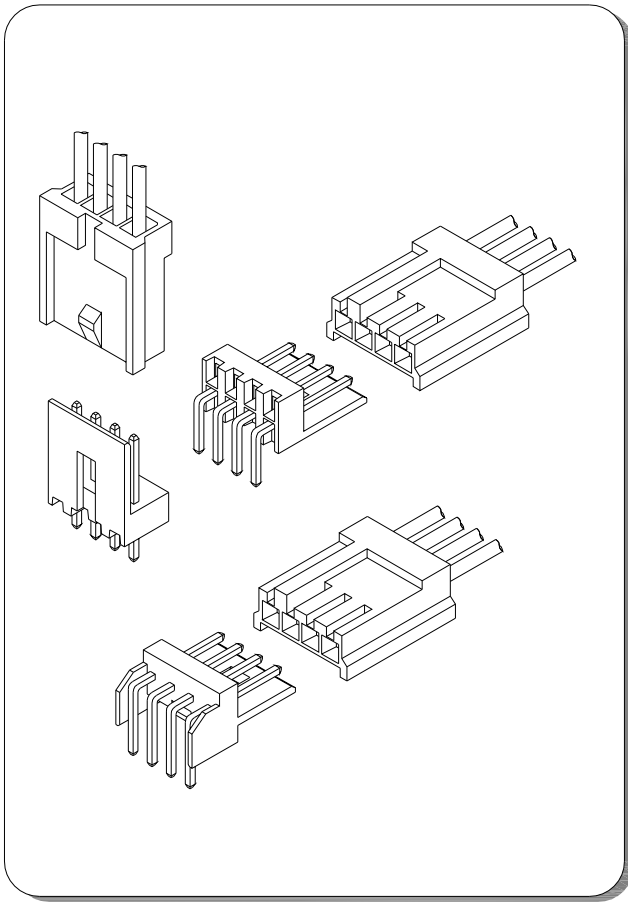

Specifications

- Current rating: 3A AC, DC
- Voltage rating: 250V AC, DC
- Temperature range: -40°C ~ +105°C
- Contact resistance: 10mΩ Max.
- Insulation resistance: 500MΩ Min.
- Withstanding voltage: 800V AC/minute
- *Compliant with RoHS and REACH*
- *Meet the HF/Halogen Free, need to customize*
- *Contact for details*

Standards



Assembly layout

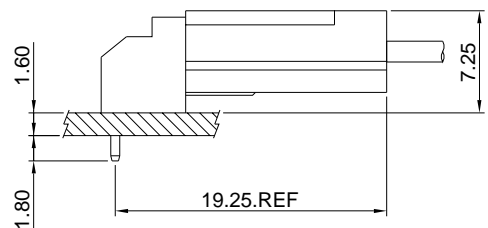
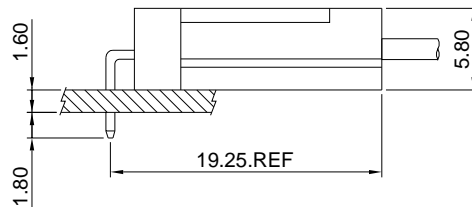
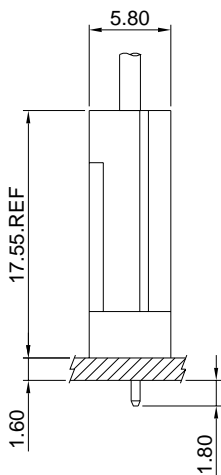

A2544 SERIES

2.50mm pitch wire to board connector

A2544-T

2.50mm Pitch Crimp Terminal

Reference Informations:

*Used in A2544 series Housing

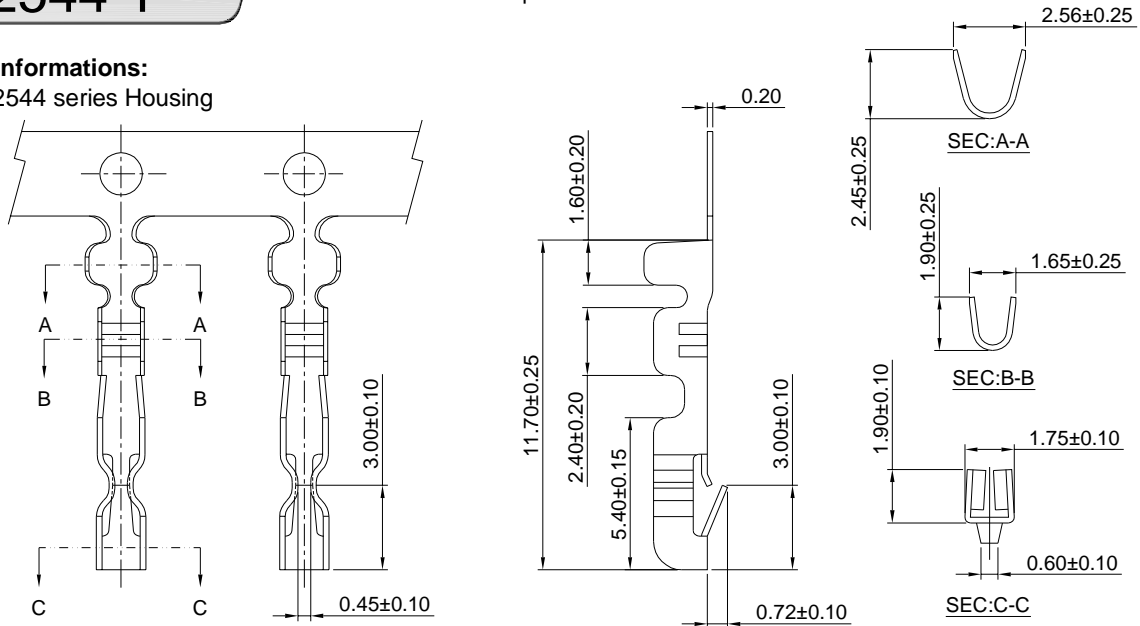

Ordering information & Specifications:

Part NO.	Wire Range	Insulation O.D.	Material	Finish	Qty/reel
A2544-TB	AWG#20-#26	1.90mm(max)	Brass	Tin over Nickel	10,000 PCS
A2544-TP	AWG#20-#26	1.90mm(max)	Phosphor Bronze	Tin over Nickel	10,000 PCS
A2544-GB	AWG#20-#26	1.90mm(max)	Brass	Gold over Nickel	10,000 PCS
A2544-GP	AWG#20-#26	1.90mm(max)	Phosphor Bronze	Gold over Nickel	10,000 PCS

Unit:mm

Optional Gold plating available but MOQ requested

A2544H

2.50mm Pitch Housing

Reference Informations:

*Material:Nylon 66 , UL94V-0

*Suitable A2544 series Terminal

*Mates with A2544 series Wafer

*Color:White

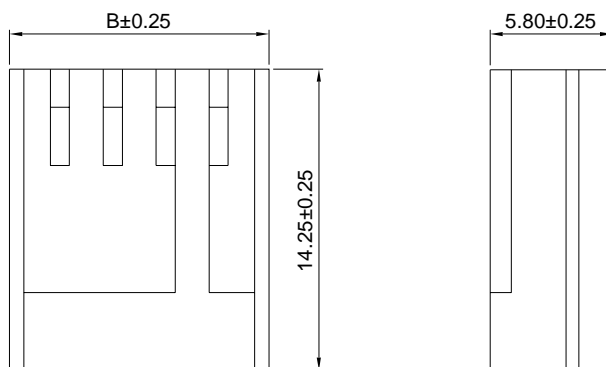
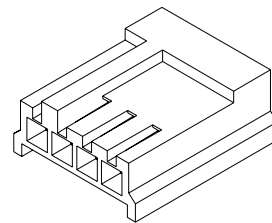
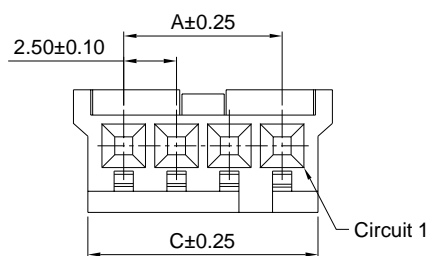

Ordering Information & Dimensions:

PART NO.	Dimensions		
	A	B	C
A2544H-2P	2.50	7.25	5.90
A2544H-3P	5.00	9.75	8.40
A2544H-4P	7.50	12.25	10.90
A2544H-5P	10.00	14.75	13.40
A2544H-6P	12.50	17.25	15.90
A2544H-7P	15.00	19.75	18.40
A2544H-8P	17.50	22.25	20.90
A2544H-9P	20.00	24.75	23.40
A2544H-10P	22.50	27.25	25.90
A2544H-11P	25.00	29.75	28.40
A2544H-12P	27.50	32.25	30.90

Unit: mm

A2544 SERIES

2.50mm pitch wire to board connector

A2544WV

2.50mm pitch 180° Wafer

Reference Informations:

- *Material:Pin:Brass/Tin over Nickel
Insulator:Nylon 66 ,UL94V-0
- *Mates with A2544 series Housing
- *Color:White

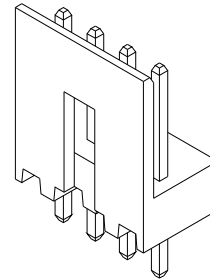
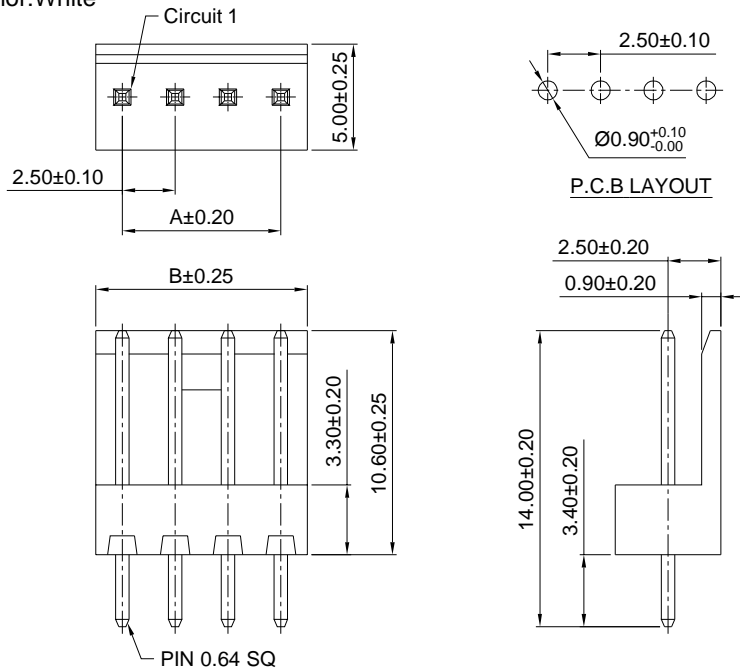

Ordering Information & Dimensions:

PART NO.	Dimensions	
	A	B
A2544WV-2P	2.50	5.00
A2544WV-3P	5.00	7.50
A2544WV-4P	7.50	10.00
A2544WV-5P	10.00	12.50
A2544WV-6P	12.50	15.00
A2544WV-7P	15.00	17.50
A2544WV-8P	17.50	20.00
A2544WV-9P	20.00	22.50
A2544WV-10P	22.50	25.00
A2544WV-11P	25.00	27.50
A2544WV-12P	27.50	30.00

Unit: mm

A2544WR

2.50mm pitch 90° Wafer

Reference Informations:

- *Material:Pin:Brass/Tin over Nickel
Insulator:Nylon 66,UL94V-0
- *Mates with A2544 series Housing
- *Color:White

Ordering Information:

A2544WR-XP - *
1 2

- 1.Part No:
- 2.Style:
(blank)-Type 1
2-Type 2

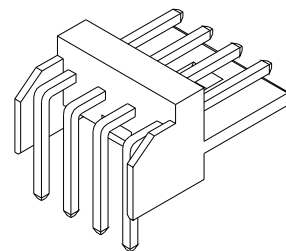
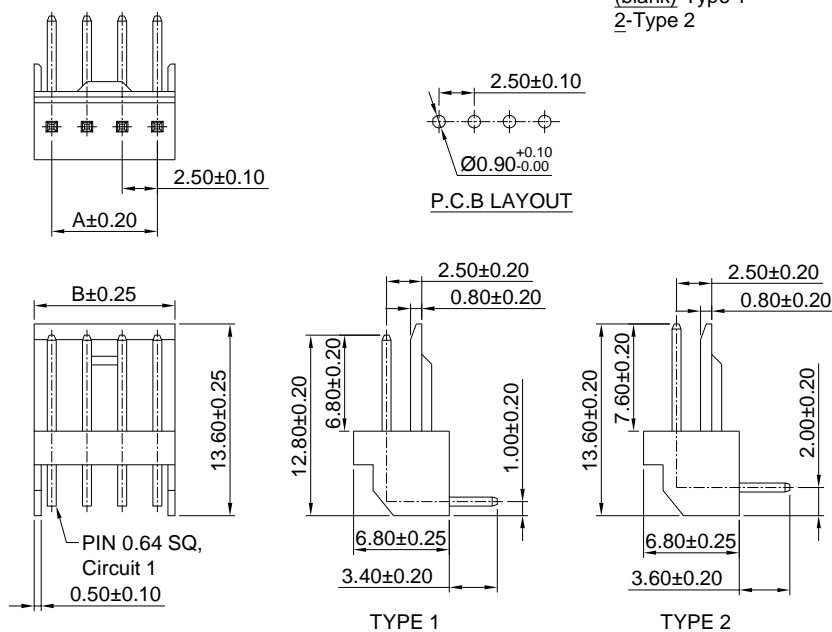

Ordering Information & Dimensions:

PART NO.	Dimensions	
	A	B
A2544WR-2P	2.50	5.00
A2544WR-3P	5.00	7.50
A2544WR-4P	7.50	10.00
A2544WR-5P	10.00	12.50
A2544WR-6P	12.50	15.00
A2544WR-7P	15.00	17.50
A2544WR-8P	17.50	20.00
A2544WR-9P	20.00	22.50
A2544WR-10P	22.50	25.00
A2544WR-11P	25.00	27.50
A2544WR-12P	27.50	30.00

Unit: mm

A2544 SERIES

2.50mm pitch wire to board connector

A2544WVR

2.50mm pitch 90° Wafer

Reference Informations:

- *Material:Pin:Brass/Tin over Nickel
Insulator:Nylon 66 ,UL94V-0
- *Mates with A2544 series Housing
- *Color:White

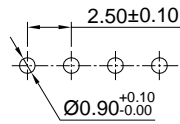
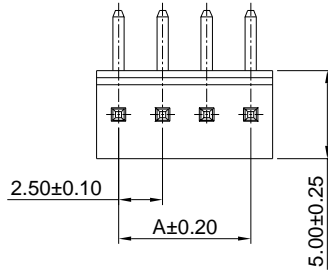

P.C.B LAYOUT

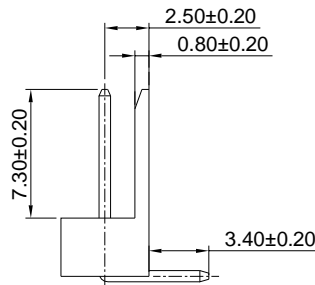
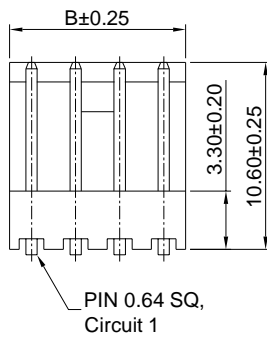
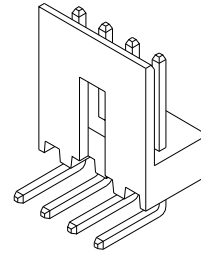

Ordering Information & Dimensions:

PART NO.	Dimensions	
	A	B
A2544WVR-2P	2.50	5.00
A2544WVR-3P	5.00	7.50
A2544WVR-4P	7.50	10.00
A2544WVR-5P	10.00	12.50
A2544WVR-6P	12.50	15.00
A2544WVR-7P	15.00	17.50
A2544WVR-8P	17.50	20.00
A2544WVR-9P	20.00	22.50
A2544WVR-10P	22.50	25.00
A2544WVR-11P	25.00	27.50
A2544WVR-12P	27.50	30.00

Unit: mm