

# A3502 SERIES

3.50mm pitch wire to board connector

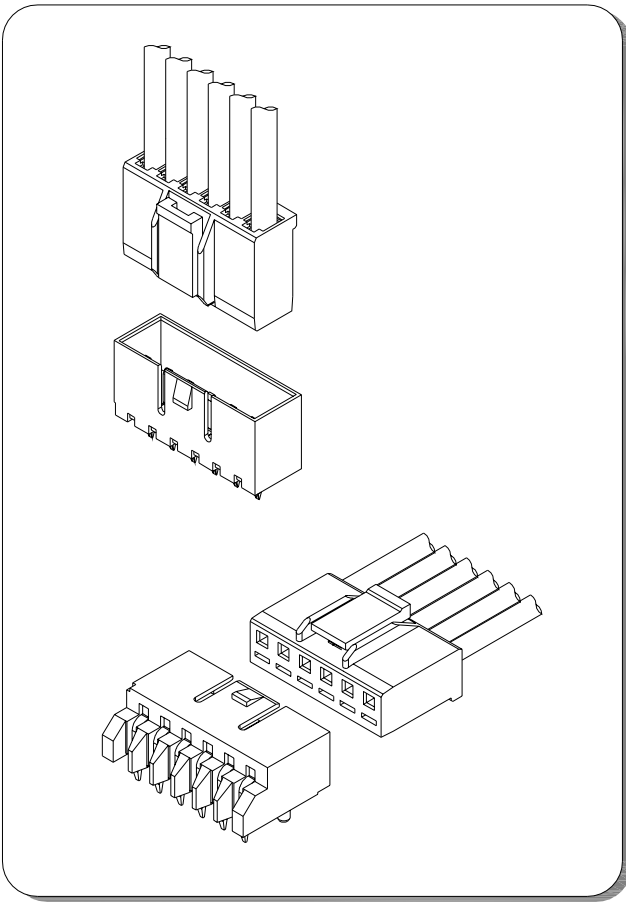

## Specifications

- Current rating: 5.5A AC, DC (Max)
- Voltage rating: 250V AC, DC
- Temperature range: -40°C ~ +105°C
- Contact resistance: 10mΩ Max.
- Insulation resistance: 1000MΩ Min.
- Withstanding voltage: 1500V AC/minute
- \*Compliant with RoHS and REACH\*
- \*Meet the HF/Halogen Free, GWT/Glow wire Test (IEC60335-1) request, need to customize\*
- \*Contact for details\*

## Standards



## Assembly layout

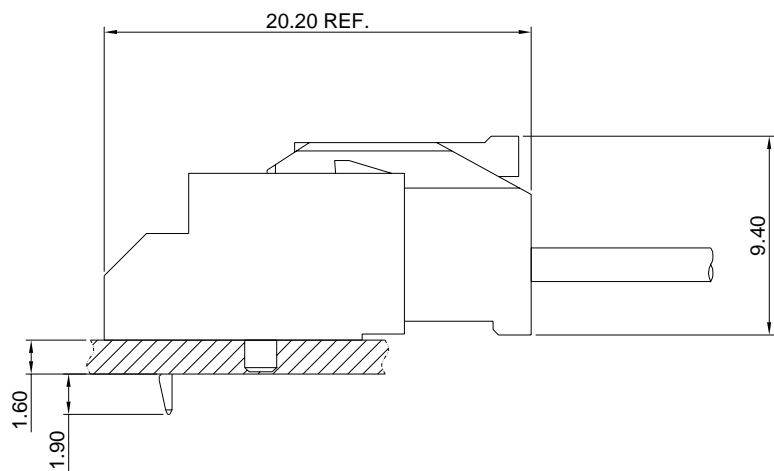
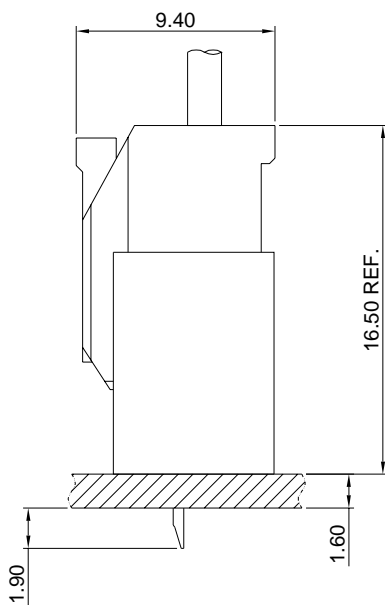

# A3502 SERIES

3.50mm pitch wire to board connector

## A3502-T

3.50mm Pitch Crimp Terminal

### Reference Informations:

\*Used in A3502 series Housing

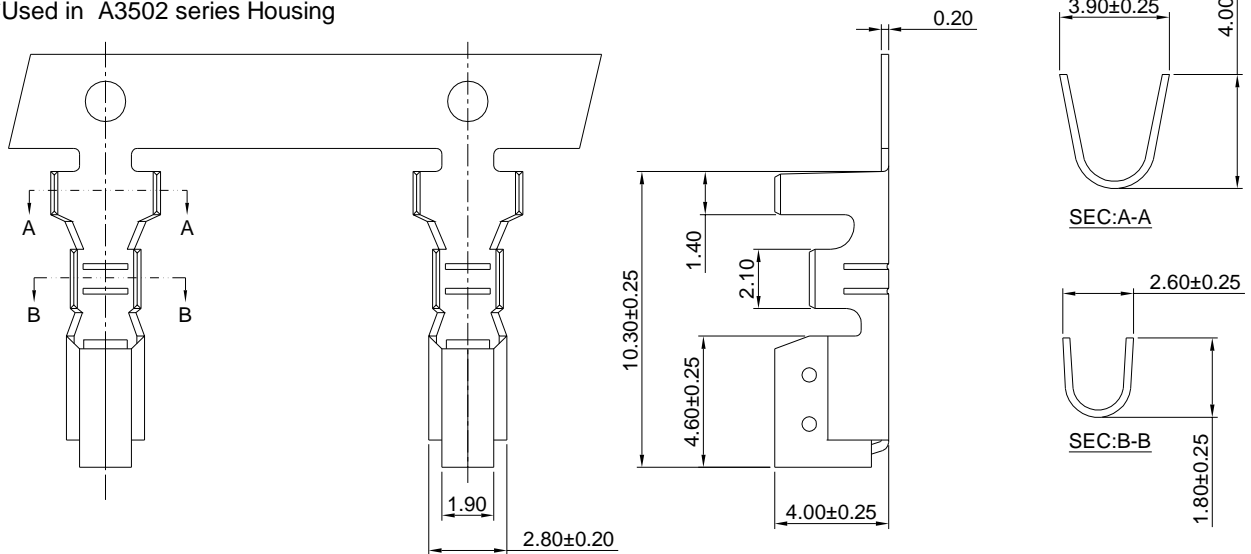

### Ordering information & Specifications:

Unit:mm

Part NO.	Wire Range	Insulation O.D.	Material	Finish	Qty/reel
A3502-TB	AWG#22-#28	3.20mm(max)	Brass	Tin over Nickel	3,500 PCS
A3502-TP	AWG#22-#28	3.20mm(max)	Phosphor Bronze	Tin over Nickel	3,500 PCS
A3502-GB	AWG#22-#28	3.20mm(max)	Brass	Gold over Nickel	3,500 PCS
A3502-GP	AWG#22-#28	3.20mm(max)	Phosphor Bronze	Gold over Nickel	3,500 PCS

Optional Gold plating available but MOQ requested

## A3502H

3.50mm Pitch Housing

### Reference Informations:

\*Material:Nylon 66 , UL94V-0

\*Suitable A3502 series Terminal

\*Mates with A3502 series Wafer

\*Color:White

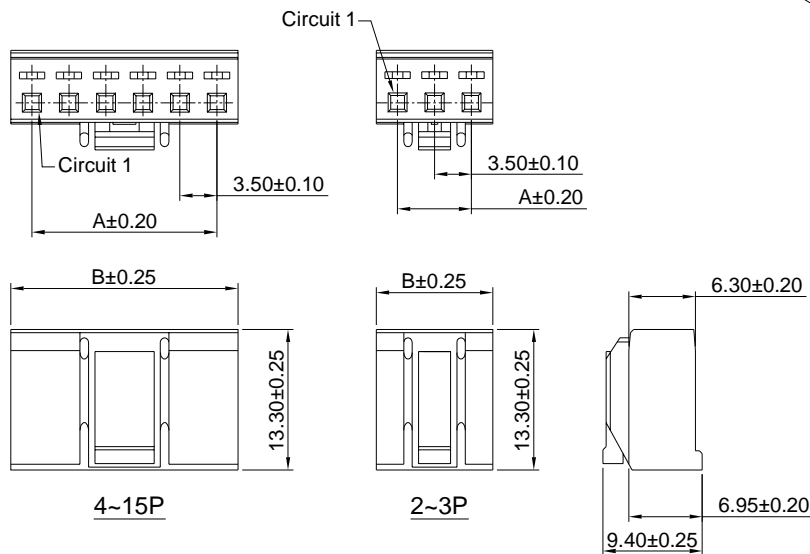
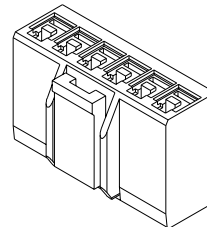

### Ordering Information & Dimensions:

PART NO.	Dimensions	
	A	B
A3502H-2P	3.50	7.50
A3502H-3P	7.00	11.00
A3502H-4P	10.50	14.50
A3502H-5P	14.00	18.00
A3502H-6P	17.50	21.50
A3502H-7P	21.00	25.00
A3502H-8P	24.50	28.50
A3502H-9P	28.00	30.00
A3502H-10P	31.50	35.50
A3502H-11P	35.00	39.00
A3502H-12P	38.50	42.50
A3502H-13P	42.00	46.00
A3502H-14P	45.50	49.50
A3502H-15P	49.00	53.00

Unit: mm

# A3502 SERIES

3.50mm pitch wire to board connector

## A3502WV

3.50mm Pitch 180° WAFER

### Reference Informations:

- \*Material:Pin:Barss/Tin over Nickel  
Insulator:PBT+15%GF , UL94V-0
- \*Mates with A3502H series Housing
- \*Color:White

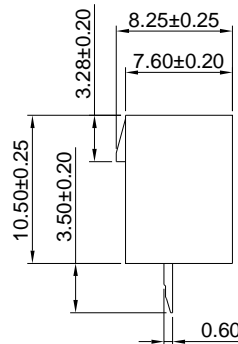
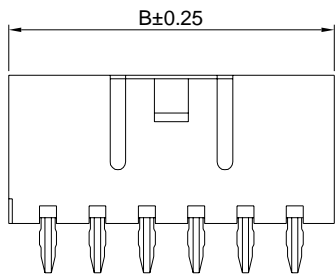
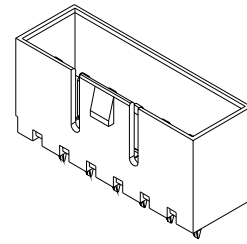
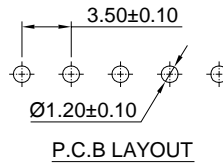
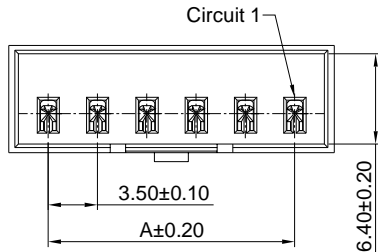

Ordering Information & Dimensions:

PART NO.	Dimensions	
	A	B
A3502WV-2P	3.50	9.10
A3502WV-3P	7.00	12.60
A3502WV-4P	10.50	16.10
A3502WV-5P	14.00	19.60
A3502WV-6P	17.50	23.10
A3502WV-7P	21.00	26.60
A3502WV-8P	24.50	30.10
A3502WV-9P	28.00	33.60
A3502WV-10P	31.50	37.10
A3502WV-11P	35.00	40.60
A3502WV-12P	38.50	44.10
A3502WV-13P	42.00	47.60
A3502WV-14P	45.50	51.10
A3502WV-15P	49.00	54.60

Unit: mm

## A3502WV-A

3.50mm Pitch 180° WAFER

### Reference Informations:

- \*Material:Pin:Barss/Tin over Nickel  
Insulator:PBT+15%GF , UL94V-0
- \*Mates with A3502H series Housing
- \*Color:White

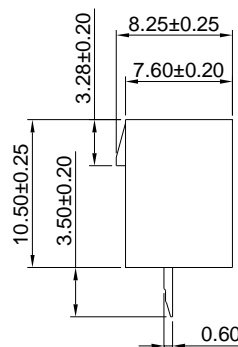
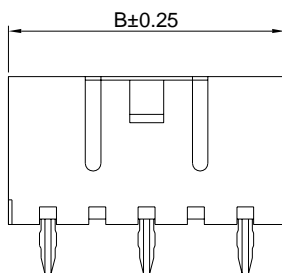
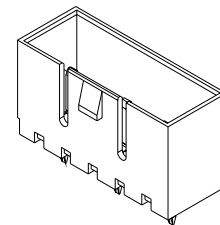
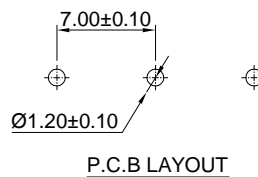
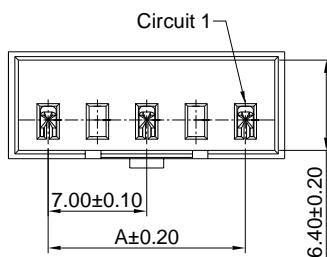

Ordering Information & Dimensions:

PART NO.	Dimensions	
	A	B
A3502WV-3P-A	7.00	12.60
A3502WV-5P-A	14.00	19.60
A3502WV-7P-A	21.00	26.60
A3502WV-9P-A	28.00	33.60
A3502WV-11P-A	35.00	40.60
A3502WV-13P-A	42.00	47.60
A3502WV-15P-A	49.00	54.60

Unit: mm

# A3502 SERIES

3.50mm pitch wire to board connector

## A3502WR

3.50mm Pitch 90° WAFER

### Reference Informations:

- \*Material: Pin: Barss/Tin over Nickel  
Insulator: PBT+15%GF, UL94V-0
- \*Mates with A3502H series Housing
- \*Color: White

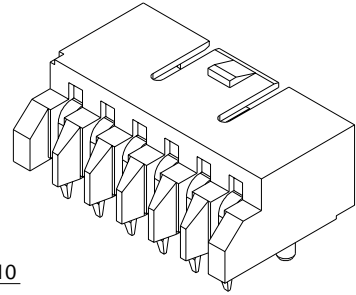
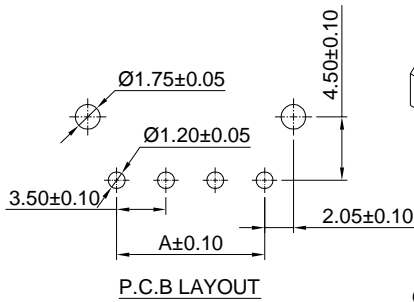
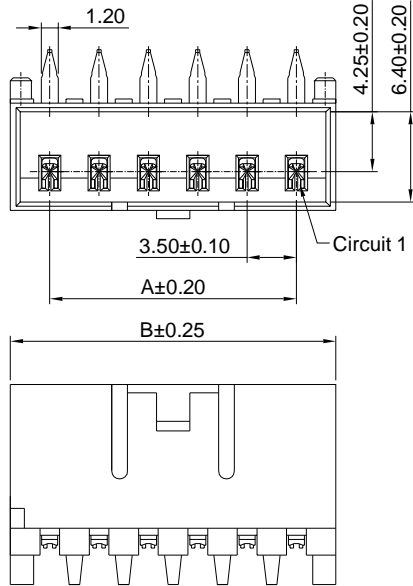

### Ordering Information & Dimensions:

PART NO.	Dimensions	
	A	B
A3502WR-2P	3.50	9.10
A3502WR-3P	7.00	12.60
A3502WR-4P	10.50	16.10
A3502WR-5P	14.00	19.60
A3502WR-6P	17.50	23.10
A3502WR-7P	21.00	26.60
A3502WR-8P	24.50	30.10
A3502WR-9P	28.00	33.60
A3502WR-10P	31.50	37.10
A3502WR-11P	35.00	40.60
A3502WR-12P	38.50	44.10
A3502WR-13P	42.00	47.60
A3502WR-14P	45.50	51.10
A3502WR-15P	49.00	54.60

Unit: mm

## A3502WR-A

3.50mm Pitch 90° WAFER

### Reference Informations:

- \*Material: Pin: Barss/Tin over Nickel  
Insulator: PBT+15%GF, UL94V-0
- \*Mates with A3502H series Housing
- \*Color: White

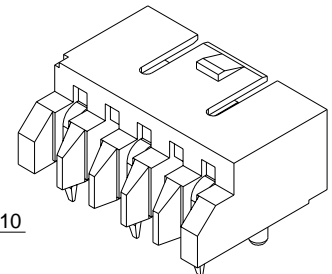
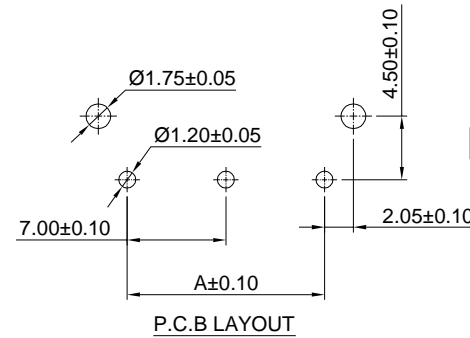
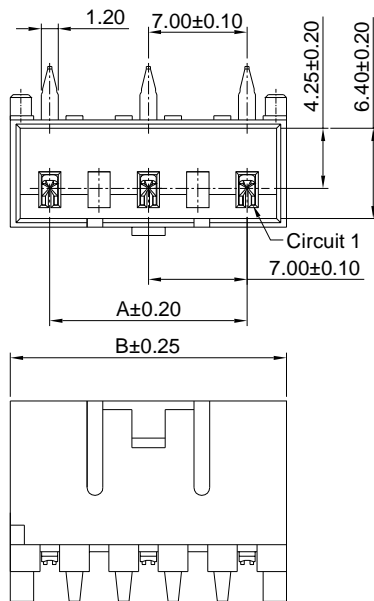

### Ordering Information & Dimensions:

PART NO.	Dimensions	
	A	B
A3502WR-3P-A	7.00	12.60
A3502WR-5P-A	14.00	19.60
A3502WR-7P-A	21.00	26.60
A3502WR-9P-A	28.00	33.60
A3502WR-11P-A	35.00	40.60
A3502WR-13P-A	42.00	47.60
A3502WR-15P-A	49.00	54.60

Unit: mm