

# A4001 SERIES

4.00mm pitch wire to board and wire to wire connector

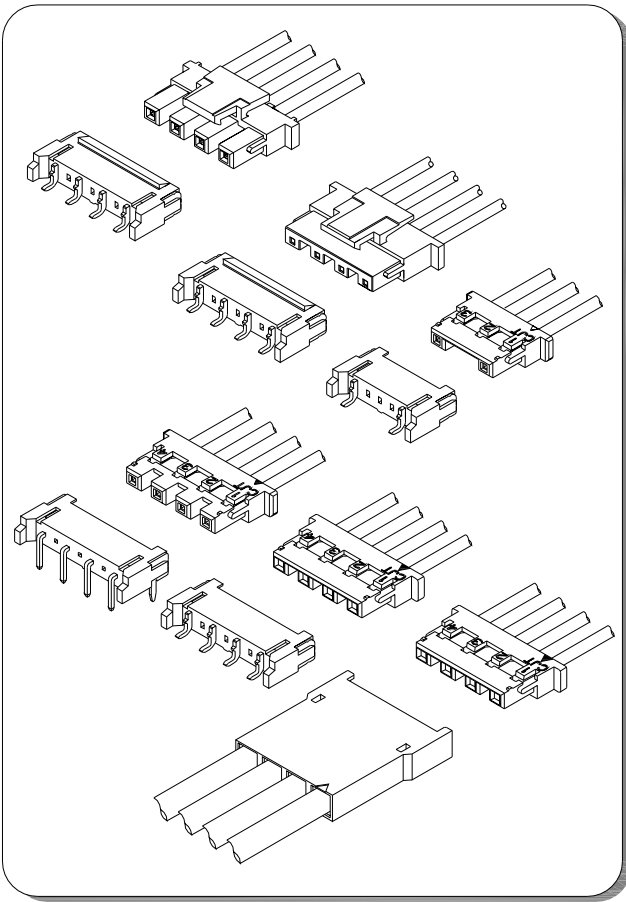

## Specifications

- Current rating: 1A AC, DC
- Voltage rating: 600V AC, DC
- Temperature range: -40°C ~ +105°C
- Contact resistance: 10mΩ Max.
- Insulation resistance: 1000MΩ Min.
- Withstanding voltage: 1800V AC/minute
- \*Compliant with RoHS and REACH\*
- \*Meet the HF/Halogen Free, GWT/Glow wire Test (IEC60335-1) request, need to customize\*
- \*Contact for details\*

## Standards



## Assembly layout

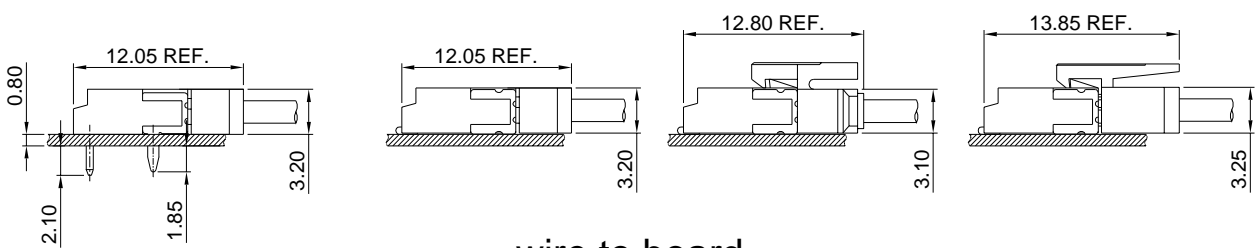

wire to board

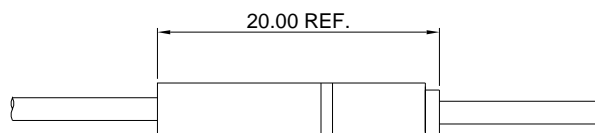

wire to wire

# A4001 SERIES

4.00mm pitch wire to board and wire to wire connector

## A4001-T

4.00mm pitch Crimp Terminal

### Reference Informations:

\*Used in A4001H or A4001HC series Housing

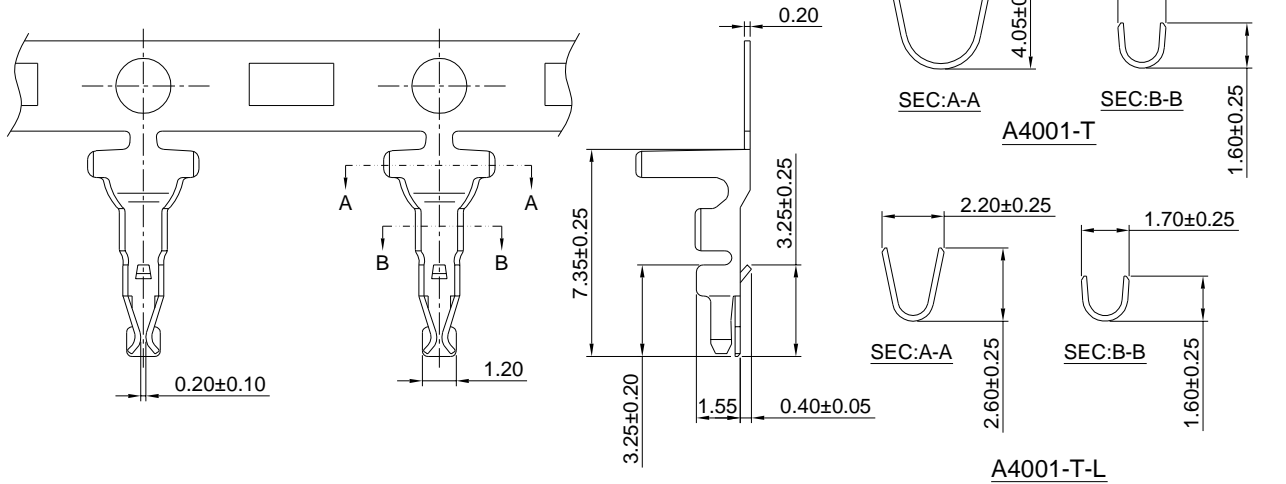

### Ordering information & Specifications:

Unit:mm

Part NO.	Wire Range	Insulation O.D.	Material	Finish	Qty/reel
A4001-TP	AWG#18-#22	3.00mm(max)	Phosphor Bronze	Tin over Nickel	5,000 PCS
A4001-GP	AWG#18-#22	3.00mm(max)	Phosphor Bronze	Gold over Nickel	5,000 PCS
A4001-TP-L	AWG#22-#28	1.60mm(max)	Phosphor Bronze	Tin over Nickel	8,000 PCS
A4001-GP-L	AWG#22-#28	1.60mm(max)	Phosphor Bronze	Gold over Nickel	8,000 PCS

Optional Gold plating available but MOQ requested

## A4001M-T

4.00mm pitch Crimp Terminal

### Reference Informations:

\*Used in A4001HM series Housing

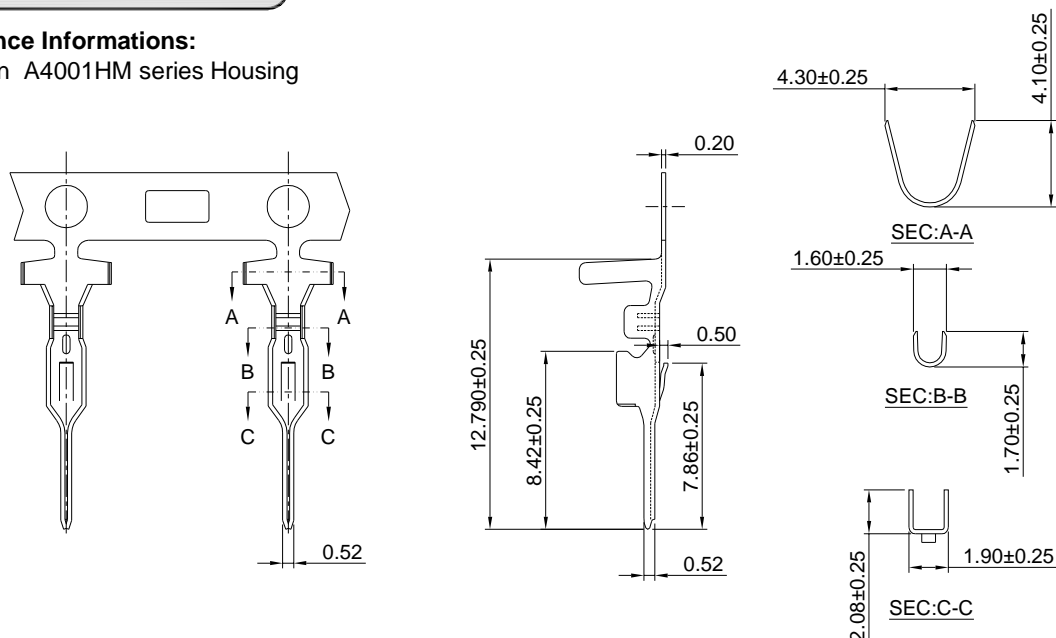

### Ordering information & Specifications:

Unit:mm

Part NO	Wire Range	Insulation O.D.	Material	Finish	Qty/reel
A4001M-TP	AWG#22-#28	2.40mm(max)	Phosphor Bronze	Tin over Nickel	5,000 PCS
A4001M-GP	AWG#22-#28	2.40mm(max)	Phosphor Bronze	Gold over Nickel	5,000 PCS

Optional Gold plating available but MOQ requested

# A4001 SERIES

4.00mm pitch wire to board and wire to wire connector

## A4001A-T

4.00mm pitch Crimp Terminal

### Reference Informations:

\*Used in A4001HA or A4001HB series Housing

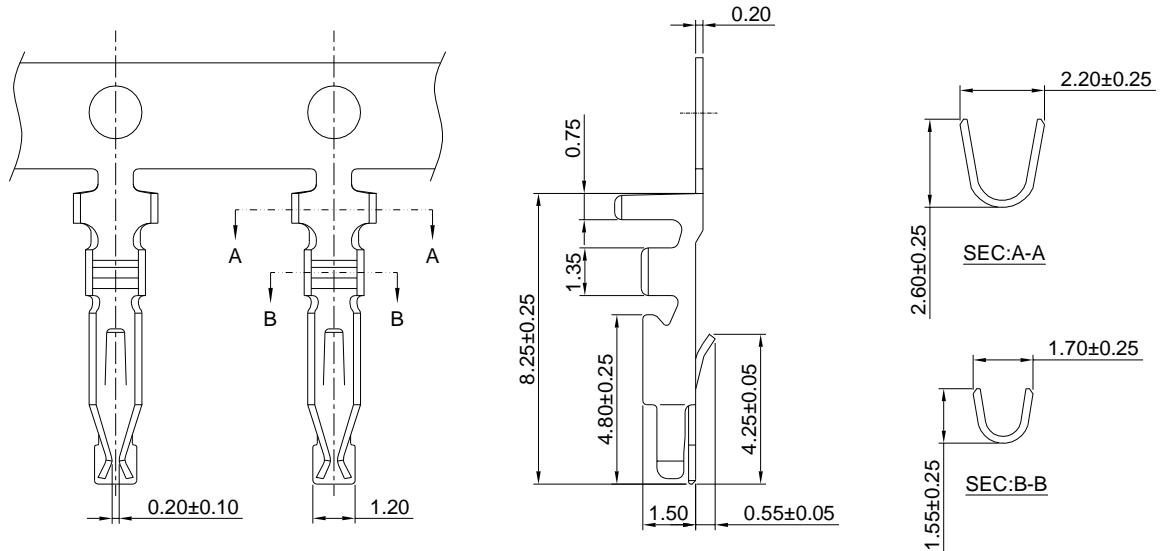

### Ordering information & Specifications:

Unit:mm

Part NO	Wire Range	Insulation O.D.	Material	Finish	Qty/reel
A4001A-TP	AWG#24-#28	1.60mm(max)	Phosphor Bronze	Tin over Nickel	10,000 PCS
A4001A-GP	AWG#24-#28	1.60mm(max)	Phosphor Bronze	Gold over Nickel	10,000 PCS

Optional Gold plating available but MOQ requested

## A4001H

4.00mm pitch Housing

### Reference Informations:

\*Material:Nylon 66,UL94V-0

\*Suitable A4001 series Terminal

\*Mates with A4001HM series Housing or A4001 series Wafer

\*Color:White

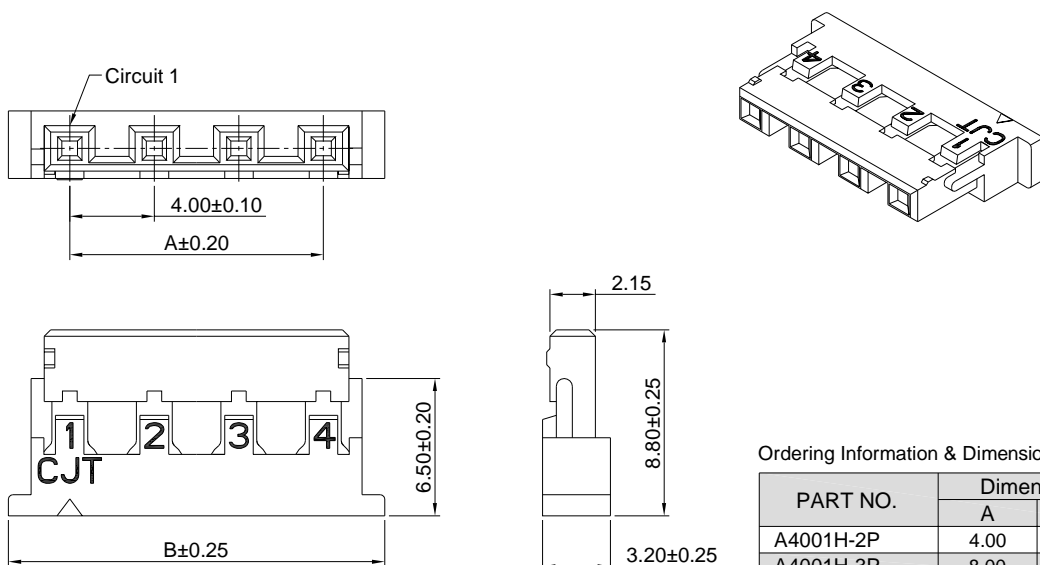

### Ordering Information & Dimensions:

PART NO.	Dimensions	
	A	B
A4001H-2P	4.00	9.80
A4001H-3P	8.00	13.80
A4001H-4P	12.00	17.80
A4001H-5P	16.00	21.80

Unit: mm

# A4001 SERIES

4.00mm pitch wire to board and wire to wire connector

## A4001HA

4.00mm pitch Housing

### Reference Informations:

- \*Material:Nylon 66,UL94V-0
- \*Suitable A4001A series Terminal
- \*Mates with A4001 series Wafer
- \*Color:White

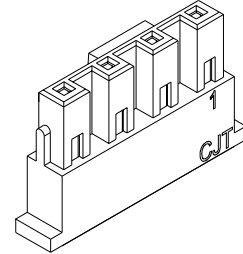
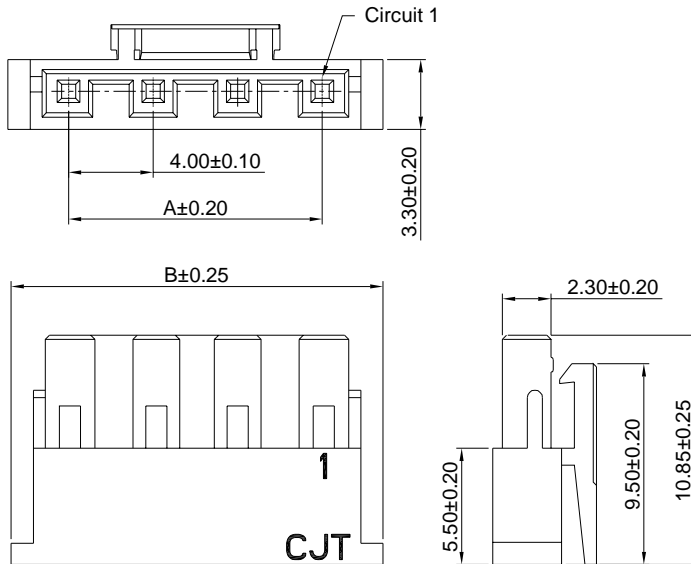

### Ordering Information & Dimensions:

PART NO.	Dimensions	
	A	B
A4001HA-2P	4.00	9.80
A4001HA-3P	8.00	13.80
A4001HA-4P	12.00	17.80
A4001HA-5P	16.00	21.80

Unit: mm

## A4001HB

4.00mm pitch Housing

### Reference Informations:

- \*Material:Nylon 66,UL94V-0
- \*Suitable A4001A series Terminal
- \*Mates with A4001 series Wafer
- \*Color:White

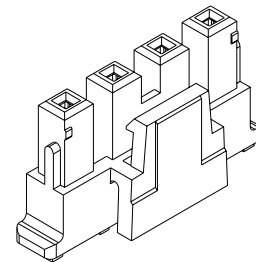
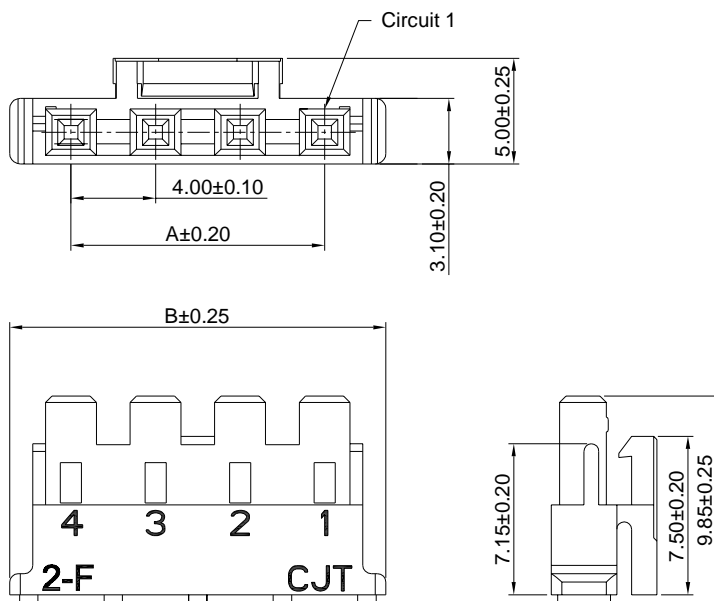

### Ordering Information & Dimensions:

PART NO.	Dimensions	
	A	B
A4001HB-2P	4.00	9.80
A4001HB-3P	8.00	13.80
A4001HB-4P	12.00	17.80
A4001HB-5P	16.00	21.80

Unit: mm

# A4001 SERIES

4.00mm pitch wire to board and wire to wire connector

## A4001HC

4.00mm pitch Housing

### Reference Informations:

- \*Material:Nylon 66,UL94V-0
- \*Suitable A4001 series Terminal
- \*Mates with A4001HM series Housing or A4001 series Wafer
- \*Color:White

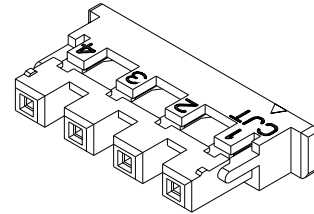
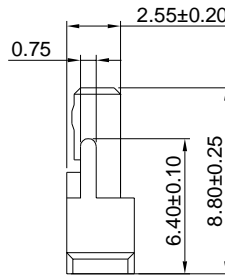
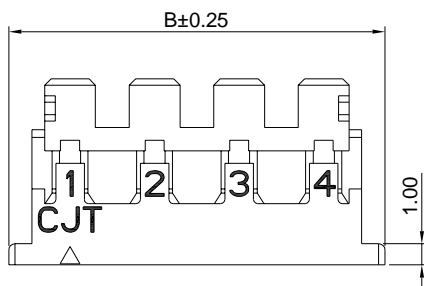
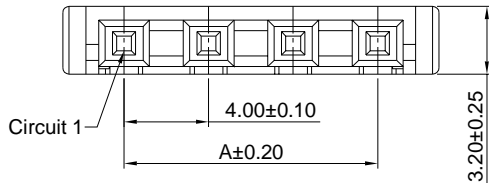

### Ordering Information & Dimensions:

PART NO.	Dimensions	
	A	B
A4001HC-2P	4.00	9.80
A4001HC-3P	8.00	13.80
A4001HC-4P	12.00	17.80
A4001HC-5P	16.00	21.80

Unit: mm

## A4001H-A

4.00mm pitch Housing

### Reference Informations:

- \*Material:Nylon 66,UL94V-0
- \*Suitable A4001 series Terminal
- \*Mates with A4001HM series Housing or A4001 series Wafer
- \*Color:White

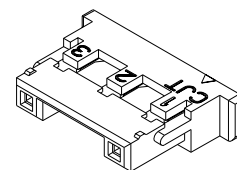
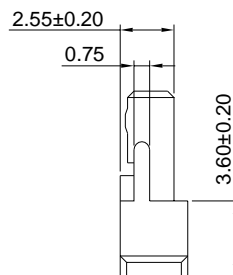
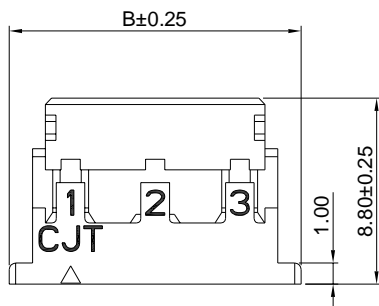
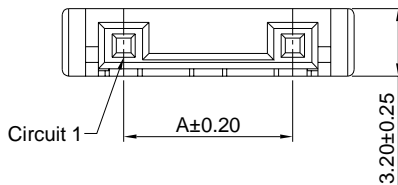

### Ordering Information & Dimensions:

PART NO.	Dimensions	
	A	B
A4001H-3P-A	8.00	13.80
A4001H-5P-A	16.00	21.80

Unit: mm

# A4001 SERIES

4.00mm pitch wire to board and wire to wire connector

## A4001HM

4.00mm pitch Housing

### Reference Informations:

- \*Material:Nylon 66,UL94V-0
- \*Suitable A4001M series Terminal
- \*Mates with A4001H series Housing
- \*Color:White

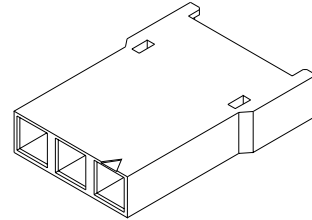
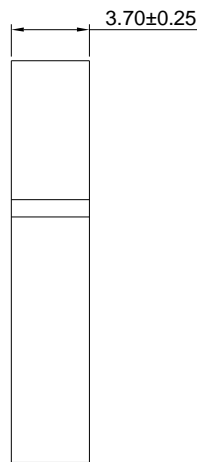
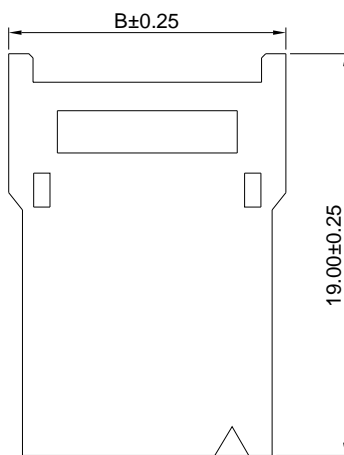
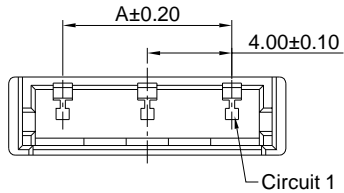

### Ordering Information & Dimensions:

PART NO.	Dimensions	
	A	B
A4001HM-2P	4.00	9.10
A4001HM-3P	8.00	13.10
A4001HM-4P	12.00	17.10
A4001HM-5P	16.00	21.10

Unit: mm

## A4001HMA

4.00mm pitch Housing

### Reference Informations:

- \*Material:Nylon 66,UL94V-0
- \*Suitable A4001M series Terminal
- \*Mates with A4001HA or A4001HB series Housing
- \*Color:White

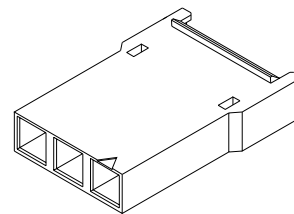
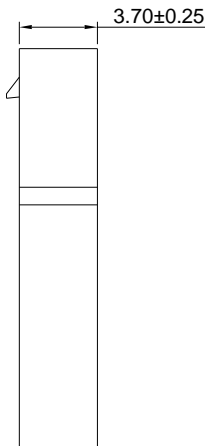
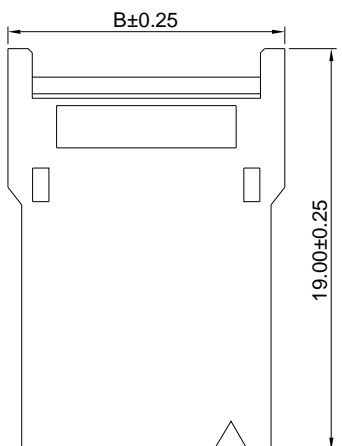
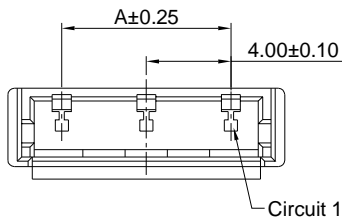

### Ordering Information & Dimensions:

PART NO.	Dimensions	
	A	B
A4001HMA-2P	4.00	9.10
A4001HMA-3P	8.00	13.10
A4001HMA-4P	12.00	17.10
A4001HMA-5P	16.00	21.10

Unit: mm

# A4001 SERIES

4.00mm pitch wire to board and wire to wire connector

## A4001WR

4.00mm pitch 90° Wafer-DIP TYPE

### Reference Informations:

- \*Material:Pin:Brass/Tin over Nickel  
Solder Pin:Brass/Tin over Nickel  
Insulator:Nylon 6T,UL94V-0
- \*Mates with JSV A4001H series Housing
- \*Color:Beige

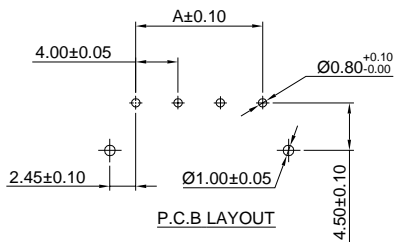
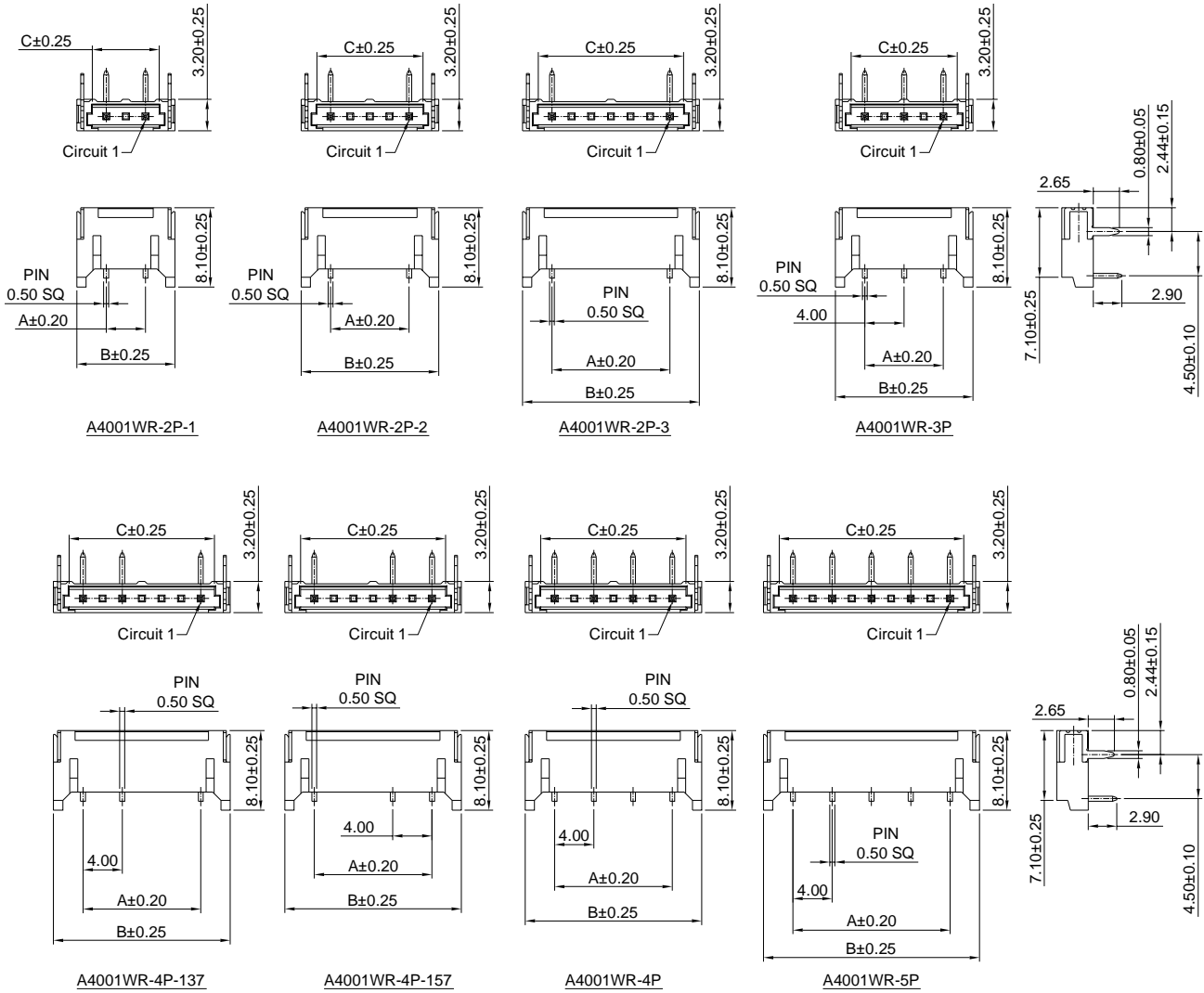
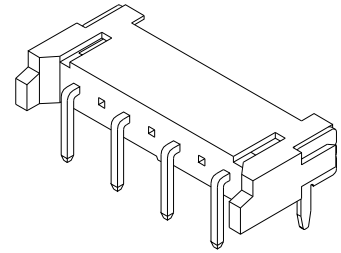

### Ordering Information & Dimensions:

PART NO.	Dimensions		
	A	B	C
A4001WR-2P-1	4.00	10.00	6.80
A4001WR-2P-2	8.00	14.00	10.80
A4001WR-2P-3	12.00	18.00	14.80
A4001WR-3P	8.00	14.00	10.80
A4001WR-4P-137	12.00	18.00	14.80
A4001WR-4P-157	12.00	18.00	14.80
A4001WR-4P	12.00	18.00	14.80
A4001WR-5P	16.00	22.00	18.80

Unit: mm

# A4001 SERIES

4.00mm pitch wire to board and wire to wire connector

## A4001WRA

4.00mm pitch 90° Wafer-DIP TYPE

### Reference Informations:

\*Material:Pin:Brass/Tin over Nickel

Solder Pin:Brass/Tin over Nickel

Insulator:Nylon 6T,UL94V-0

\*Mates with A4001HA or A4001HB series Housing

\*Color:Beige

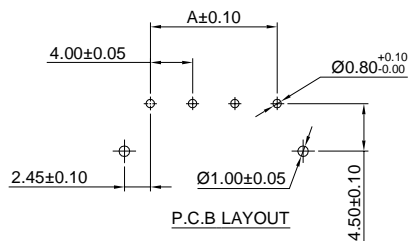
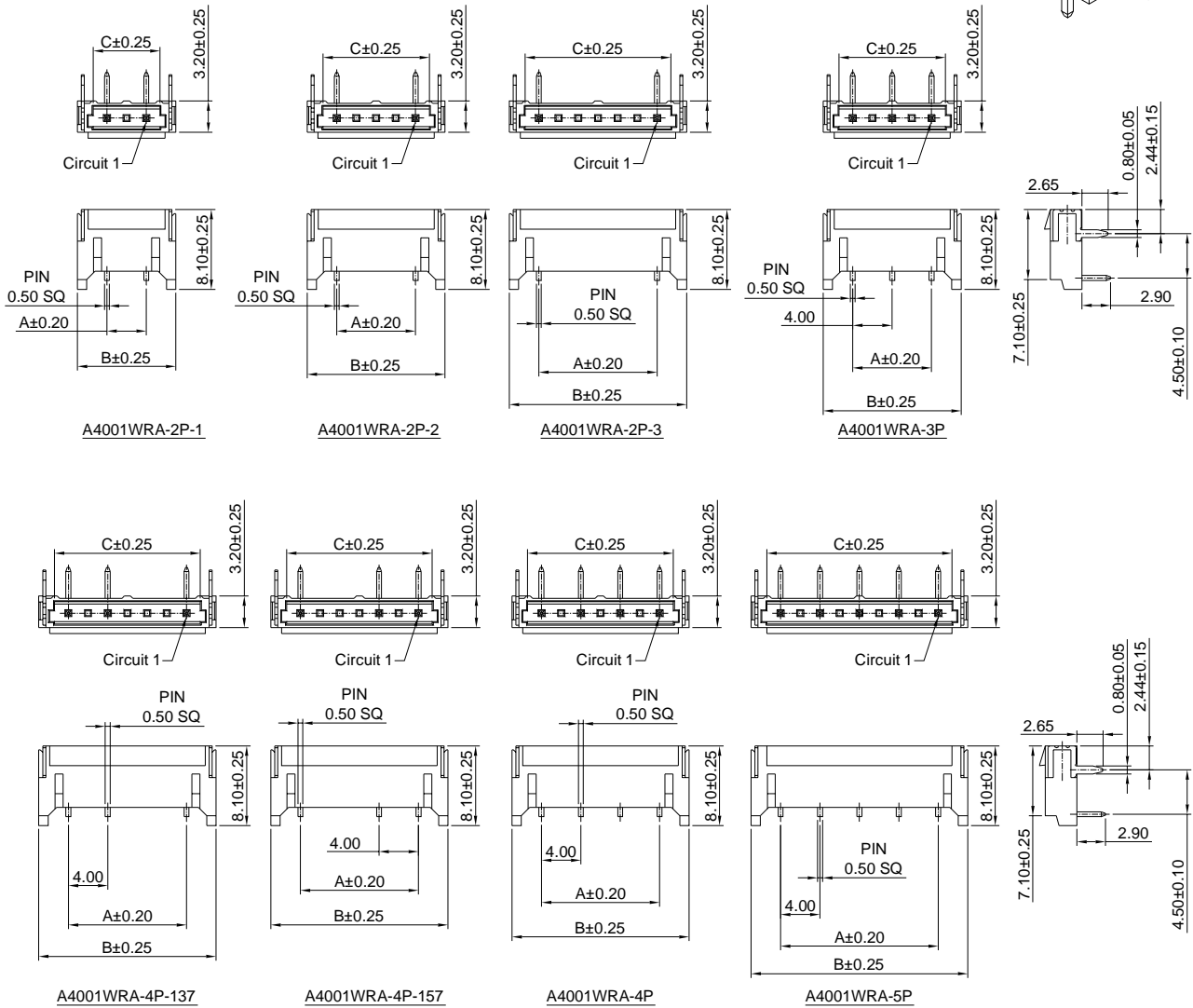
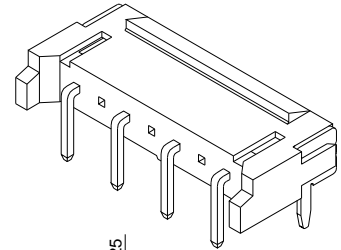

### Ordering Information & Dimensions:

PART NO.	Dimensions		
	A	B	C
A4001WRA-2P-1	4.00	10.00	6.80
A4001WRA-2P-2	8.00	14.00	10.80
A4001WRA-2P-3	12.00	18.00	14.80
A4001WRA-3P	8.00	14.00	10.80
A4001WRA-4P-137	12.00	18.00	14.80
A4001WRA-4P-157	12.00	18.00	14.80
A4001WRA-4P	12.00	18.00	14.80
A4001WRA-5P	16.00	22.00	18.80

Unit: mm



# A4001 SERIES

4.00mm pitch wire to board and wire to wire connector

## A4001WR-S

4.00mm pitch 90° Wafer-SMT TYPE

### Reference Informations:

- \*Material:Pin:Brass/Tin over Nickel  
Solder Tabs:Brass/Tin over Nickel  
Insulator:Nylon 6T,UL94V-0
- \*Mates with A4001H series Housing
- \*Color:Beige

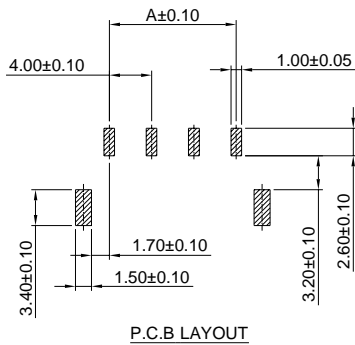
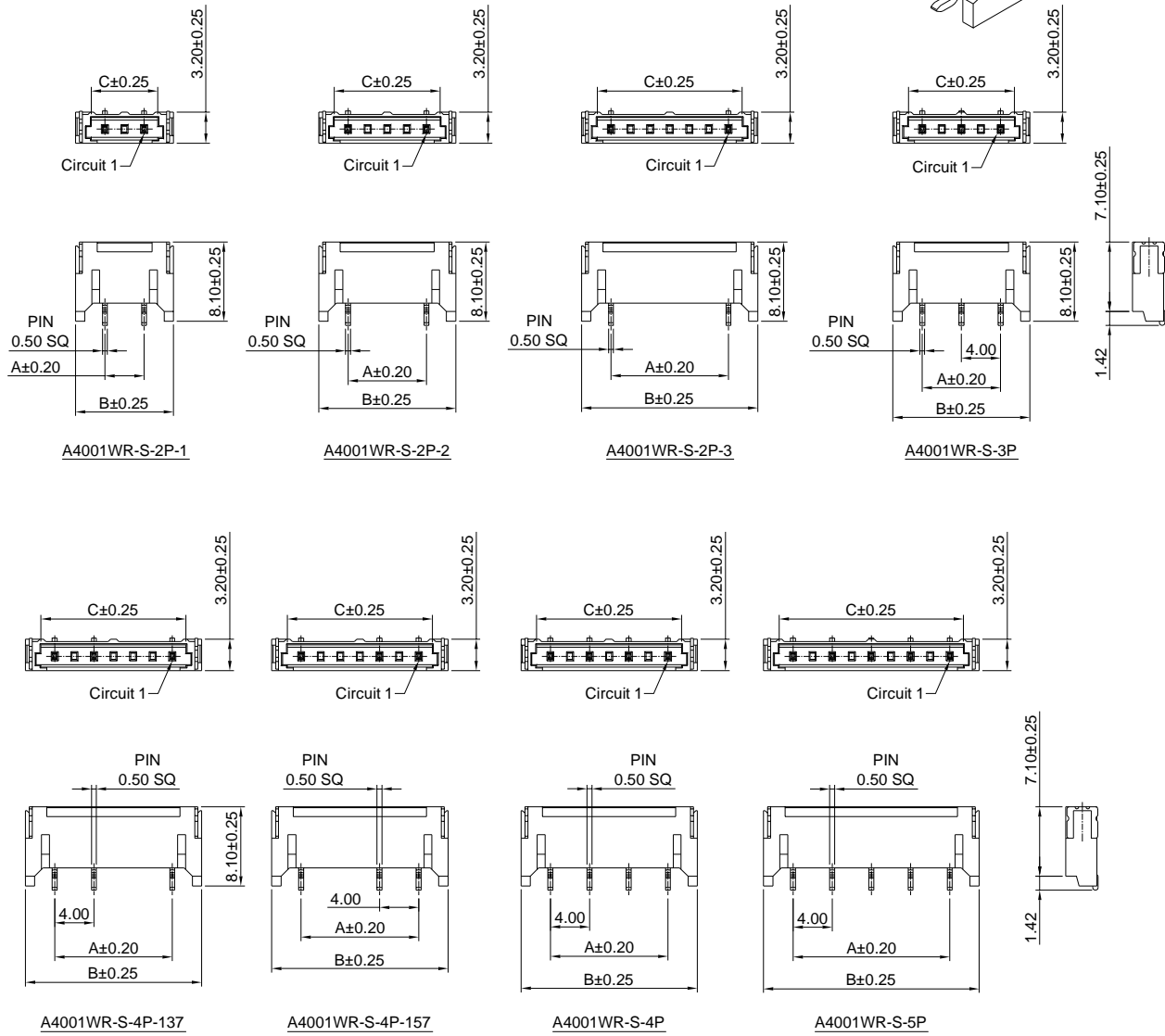
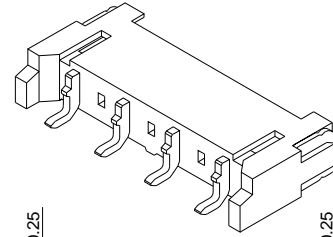

### Ordering Information & Dimensions:

PART NO.	Dimensions		
	A	B	C
A4001WR-S-2P-1	4.00	10.00	6.80
A4001WR-S-2P-2	8.00	14.00	10.80
A4001WR-S-2P-3	12.00	18.00	14.80
A4001WR-S-3P	8.00	14.00	10.80
A4001WR-S-4P-137	12.00	18.00	14.80
A4001WR-S-4P-157	12.00	18.00	14.80
A4001WR-S-4P	12.00	18.00	14.80
A4001WR-S-5P	16.00	22.00	18.80

Unit: mm

# A4001 SERIES

4.00mm pitch wire to board and wire to wire connector

## A4001WRA-S

4.00mm pitch 90° Wafer-SMT TYPE

### Reference Informations:

- \*Material:Pin:Brass/Tin over Nickel  
Solder Tabs:Brass/Tin over Nickel  
Insulator:Nylon 6T,UL94V-0
- \*Mates with A4001HA or A4001HB series Housing
- \*Color:Beige

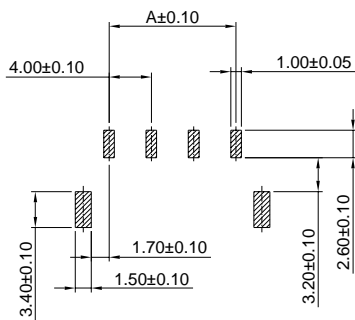
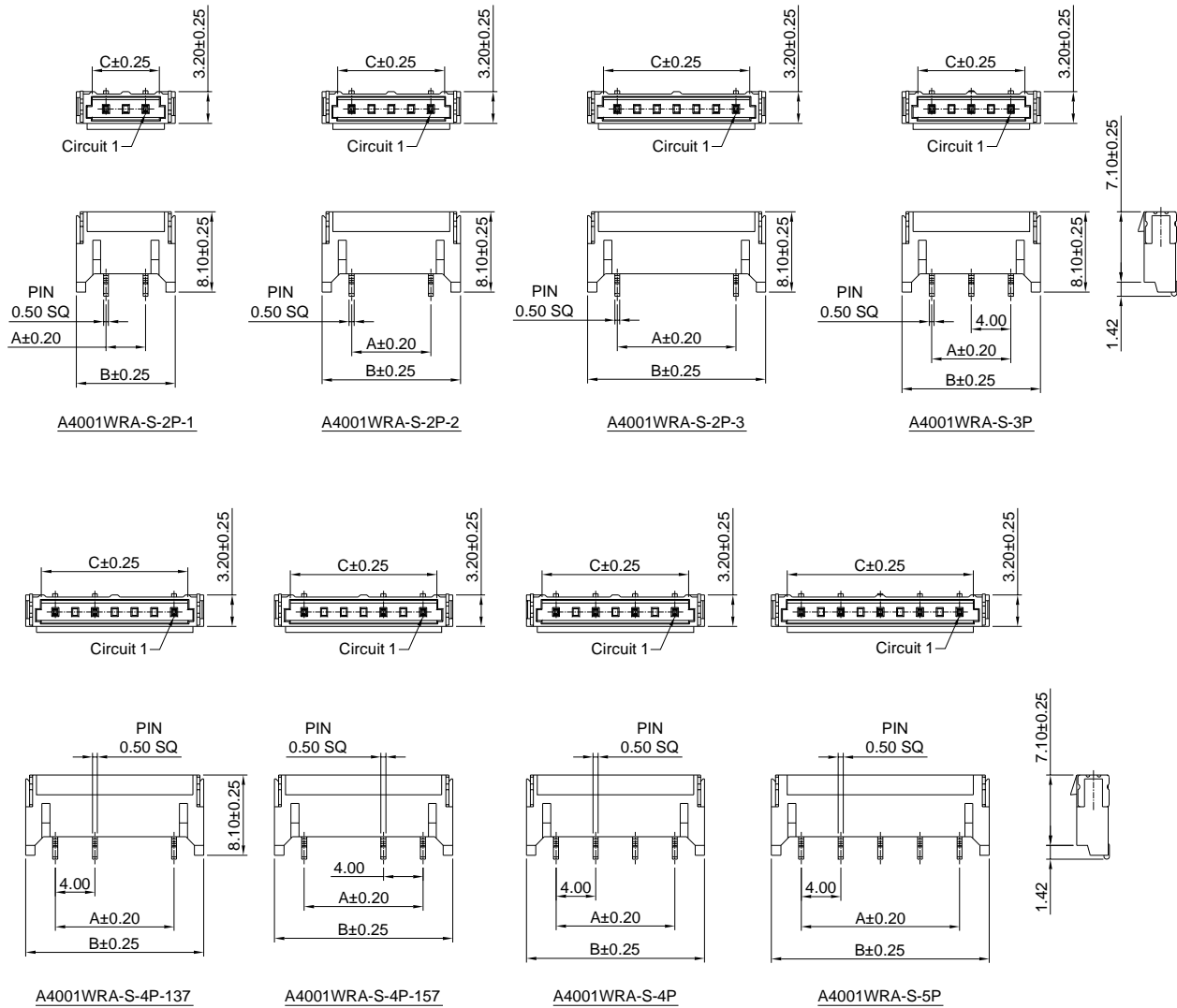
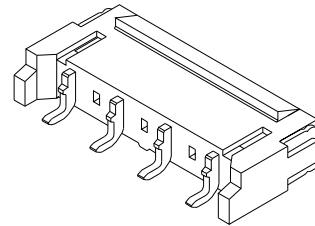

### Ordering Information & Dimensions:

PART NO.	Dimensions		
	A	B	C
A4001WRA-S-2P-1	4.00	10.00	6.80
A4001WRA-S-2P-2	8.00	14.00	10.80
A4001WRA-S-2P-3	12.00	18.00	14.80
A4001WRA-S-3P	8.00	14.00	10.80
A4001WRA-S-4P-137	12.00	18.00	14.80
A4001WRA-S-4P-157	12.00	18.00	14.80
A4001WRA-S-4P	12.00	18.00	14.80
A4001WRA-S-5P	16.00	22.00	18.80

Unit: mm